

# THE FISHER

*Master Audio Control*



INSTALLATION, OPERATING  
AND SERVICE INSTRUCTIONS



SERIES 80-C

PRICE: \$1.00

FISHER RADIO CORPORATION • NEW YORK



# THE FISHER

## Master Audio Control • Series 80-C

### GENERAL DESCRIPTION

THE FISHER Master Audio Control, Series 80-C, has been designed to specifications so far beyond those of conventional control units, that it will long-serve as the ultimate standard of comparison. In flexibility, flawless performance, beauty of appearance and workmanship, the Series 80-C is a masterpiece. The quality of its performance will be limited only by the quality of the associated equipment.

The 80-C has features normally encountered in professional studio consoles, but designed for simplicity of operation. This has resulted in a unit ideally suited to the faithful reproduction of music. These features include complete mixing and fading facilities for from two to five channels, tape input to operate directly from tape playback head, sixteen combinations of phonograph equalization, an accurately calibrated **LOUDNESS BALANCE CONTROL**, push-button **CHANNEL SELECTORS**, which, in addition to selecting the audio input channels, also operate the AC power to auxiliary equipment, and, individual channel indicator pilot lights.

Advanced engineering has resulted in circuitry that surpasses even the very high standards for which Fisher Radio Corporation is known. An exclusive input circuit, utilizing negative feedback, enables the use of one, or the mixing of as many as five signal sources, without degradation of noise performance and interaction effects normally encountered in conventional mixing circuits. All amplifying circuits, tone control circuits, and cathode followers, are included within four negative feedback loops, resulting in stability so great that performance specifications will be met without special tube selection. Harmonic and intermodulation distortion, as well as hum and noise, are thereby kept to an absolute minimum and uniform frequency response is assured. **BALANCED-SPECTRUM BASS** and **TREBLE TONE** Controls offer an infinite number of tonal compensation settings at all listening levels. Individual cathode follower

output stages, one for the Recorder Output, and one for the Main Output, maintain independence from load variations and output cable length.

The phonograph and tape preamplifier comprises two cascaded triode stages, designed for extremely low noise and hum. Both treble and bass equalization are accomplished with a unique feedback circuit, chosen for minimum distortion and circuit uniformity. The completely separate microphone preamplifier has sufficient gain to accommodate even low-level, high quality microphones. A self-contained power supply provides DC for all filaments, resulting in a hum level that is inaudible even under extreme operating conditions. To assure freedom from microphonics, all tubes and associated components are shock-mounted on a separate sub-chassis. Terminal board construction results in extreme uniformity from unit to unit. All controls are functionally arranged on an attractive, sloped, brushed-brass panel. Because of its unique design, the entire unit can be mounted either in its own cabinet (available separately in mahogany as THE FISHER Model CM, and in blonde as THE FISHER Model CB.) Or it can be mounted in a custom installation, without visible mounting screws.

### SPECIFICATIONS

**INPUTS:** Total of seven. Three high-level inputs (0.5 megohm.) One Magnetic Phono Cartridge low level input. One Constant Amplitude Cartridge input. One Microphone input (18 megohms.) One Tape-Playback input (low level, high impedance.) Two to five inputs may be mixed and used simultaneously without interaction between channels. See FIGURE 2.

**OUTPUT IMPEDANCES:** Both recorder and main audio outputs are from cathode followers, permitting leads up to 100 feet in length (based on low capacity shielded cable having a capacity of 25 mmfd per foot, such as microphone cable.) Recommended load impedance: 100,000 ohms or greater, 2500 mmfd or less.

**MAXIMUM GAIN:** From high level inputs to Main Output: 21 db. From low level inputs to Main Output: in excess of 53 db. From high level inputs to Recorder Output: 3 db.

**DISTORTION:** Harmonic: 0.02% for 1 volt; 0.05% for 5 volts; 0.12% for 10 volts; 0.22% for 15 volts; 0.37% for 20 volts. Intermodulation: non-measurable up to 5 volts; 0.2% for 10 volts; 0.65% for 15 volts.

**FREQUENCY RESPONSE:**  $\pm 0.25$  db from 20 to 20,000 cycles with **TONE** Controls in uniform response position;  $\pm 2$  db from 10 to 100,000 cycles with **TONE** Controls in uniform position.

**HUM AND NOISE LEVEL:** High-level inputs — completely non-measurable, with **VOLUME CONTROL** at zero. Better than 85 db below signal (2 volts output,) with **VOLUME CONTROL** at maximum. On phono input: 72 db below output, with a 10 mv input signal.

**CONTROLS:** The **MASTER VOLUME CONTROL** operates either conventionally or as a **LOUDNESS BALANCE CONTROL** accurately calibrated to the reciprocal of the Fletcher-Munson curves. **LOUDNESS BALANCE SWITCH;** **FIVE CHANNEL SELECTOR PUSH-BUTTONS,** for selecting one or more channels. **LOW and HIGH FREQUENCY EQUALIZATION SWITCHES** provide independent adjustment of low frequency turnover and high frequency roll-off, offering a total of sixteen combinations of equalization. These switches also have a setting for correctly equalized **TAPE HEAD PLAYBACK** in accordance with **NARTB** tape playback characteristics. **BASS and TREBLE TONE CONTROLS** are of the variable cross-over feedback type and produce up to 15 db of boost or attenuation at 50 and 10,000 cycles respectively. Marker dots indicate precise setting for uniform response throughout the range. The **AC POWER SWITCH** on the **MASTER VOLUME CONTROL** shaft operates a self-contained power supply and three AC receptacles for associated equipment. Two of these receptacles are actuated only when corresponding **CHANNEL SELECTOR BUTTONS** are engaged. There are five independent **MIXER LEVEL CONTROLS** for equalizing the level of all signal sources, as well as mixing and fading of two or more signals.

**POWER SUPPLY:** Self-contained, including a fully shielded and potted power transformer, a full-wave selenium rectifier for B-Plus and a bridge-type selenium rectifier to supply DC to the filaments. Power source: 105-125 volts, 50-60 cycles. Power consumption: 20 watts.

**TUBE COMPLEMENT:** 3-12AX7, 1-12AU7A

**SIZE:** **CHASSIS,** including projecting knobs and jacks:  $12\frac{3}{4}'' \times 7\frac{3}{4}'' \times 4\frac{1}{4}''$  high  
**CABINET:**  $13-11/16'' \times 8'' \times 5\frac{1}{4}''$  high  
**Panel:**  $4\frac{1}{4}'' \times 12\frac{3}{4}''$

**SHIPPING WEIGHT:** Chassis, 10 pounds.

## INSTALLATION INSTRUCTIONS

### CUSTOM INSTALLATION

When installing the Series 80-C chassis in a panel or wall, make the cut-out in accordance with **FIGURE 1**. Drill the necessary holes in the mounting shelf in accordance with the template supplied. Chassis mounting hardware will be found in the accessory envelope supplied with the Series 80-C. Insert the entire unit from the front of the cabinet, until the rear edge of the brushed-brass designation panel is in contact with the wood panel at all points. Then fasten it in place with the chassis mounting hardware supplied. If your cabinet has decorative molding on the front which extends above shelf level, mount the Series 80-C on a suitable board, in order to clear this molding. In the latter case, drill the holes in this *auxiliary board*, using the template. Remove the brass designation panel as follows: First pull off the two **PHONO** lever switch knobs as well as the five **MIXER LEVEL CONTROL** knobs. Next, remove the dual knobs at the left and right sides of the unit by pulling them forward. Remove the hexagonal nuts from the left and right control shafts. The designation panel will then come free. Mount and screw the chassis to the mounting board and insert into the cabinet from the rear.

FIGURE 1.  
DIMENSIONS FOR PANEL CUTOUT

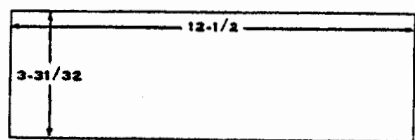

THIS EDGE TO BE FLUSH WITH THE TOP SURFACE OF CHASSIS MOUNTING BOARD OR SHELF

Re-assemble the designation panel from the front, reversing the procedure outlined above. Finally, adjust the location of the unit so that the rear edges of the designation panel are flush with the wood panel and screw the mounting board to the cabinet by means of suitable wood screws. For installation in **THE FISHER** Custom Cabinets Model **CM** or **CB** see instructions appearing on these cabinets.

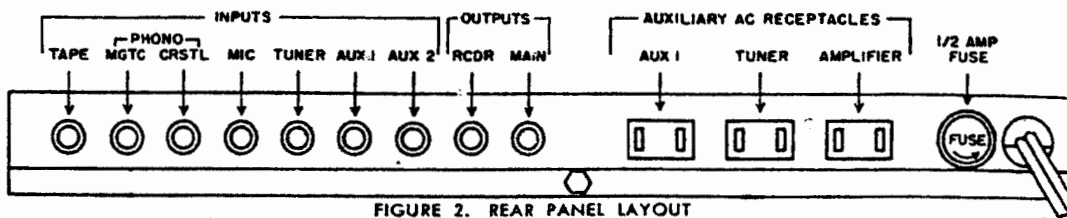

FIGURE 2. REAR PANEL LAYOUT

### ELECTRICAL INSTALLATION

**AC POWER CONNECTIONS.** THE FISHER MASTER AUDIO CONTROL, Series 80-C operates on 105-125 volts, 50-60 cycle AC. Three auxiliary AC receptacles will be found on the rear apron (see FIGURE 2.) These can be used for an FM-AM tuner, amplifier, and any other auxiliary equipment such as a tape recorder, etc. **CAUTION:** Make certain that the power consumed from any *one* receptacle does not exceed 350 watts and that the combination of *all* auxiliary power does not exceed 600 watts. In connecting the power cords of auxiliary equipment to the Series 80-C, follow the designations shown above the receptacles. That is, connect the tuner to the receptacle labeled TUNER AC, the amplifier to the AC receptacle labeled AMPL AC, etc. The exclusive FISHER circuitry of this unit has been engineered to supply power to your auxiliary equipment **ONLY** when needed, completely automatically. Thus your tuner, for example, need never dissipate wasted power when you are listening to phonograph recordings.

**INPUT CONNECTIONS.** Inputs Aux 1 and Aux 2 are electrically identical and may be used for playback from self-contained tape recorders, for TV sound, or any other signal source having at least 0.1 volt output. Only the Aux 1 input has the power-conserving feature described above, and should therefore be used for that auxiliary equipment which you want turned off automatically when it is not in use. Any FM or FM-AM tuner can be connected to the appropriately marked input. On a tuner having its own tone controls, connection should be made directly to the detector output (before the tone controls) if possible. Most tuners identify this output as "Detector Output." One low-level input, identified as MGTC, is for connection to magnetic phonograph cartridges such as the GE, Pickering, Audak, etc. The adjacent phono input, labeled CRSTL, is for connection to Ceramic, Crystal, FM type, or any other Constant Amplitude cartridges. These two phono inputs *cannot* be used simultaneously. There is a third low-level input for use with most dynamic, crystal, or ribbon microphones. Finally, the input identified as TAPE is for direct con-

nection of the playback head of any tape recorder or tape transport mechanism, for listening to pre-recorded tape. All input connections are made by means of standard RETMA type plugs. These are supplied with the equipment.

**OUTPUT CONNECTIONS.** The output of the Series 80-C can be connected directly to any of THE FISHER Amplifiers or to any amplifier having a minimum sensitivity of three volts. Connection to the amplifier is made from the MAIN OUTPUT jack (see FIGURE 2) to the input of the power amplifier by means of the pin-to-pin cable supplied. However, the distance between units need not be limited by this cable length. Any length up to one hundred feet can be used. A second output will be found on the rear apron of the Series 80-C, marked RCDR. This output can be used to feed a signal to the input of a tape, wire, or disc recorder having its own amplifier. The Series 80-C TONE and VOLUME Controls do not affect the signal at *this* output. In that way, the main output can be varied with the MASTER VOLUME and TONE Controls for monitoring purposes, without affecting the recording.

### OPERATING INSTRUCTIONS

#### INITIAL SET-UP

- 1: Turn all MIXER LEVEL CONTROLS to zero (fully counter-clockwise.)
- 2: Turn MASTER VOLUME CONTROL to zero.
- 3: Set TONE CONTROLS to uniform response position (indicator dots at the top.)
- 4: Set the LOUDNESS BALANCE switch in the OFF position.
- 5: Release all CHANNEL SELECTOR BUTTONS by depressing any one of them slightly.
- 6: The LF and HF switches can be left in any position.

#### TUNER OPERATION

Before proceeding with the following, connect the tuner in accordance with the instructions above, under INPUT CONNECTIONS. If it is not possible to by-pass the volume and/or tone controls of the tuner, set its tone controls to their uniform response position, turn up the volume control about half way and turn on the tuner power switch. **IT SHOULD NOT LIGHT UP, AS YET.** Turn on the power switch of the

Series 80-C by rotating the MASTER VOLUME CONTROL slightly clockwise until a click is heard. Press the TUNER CHANNEL SELECTOR Button. The jewelled indicator light directly below the button will show that this channel is now in use. Allow sufficient time for the tuner to warm up. Rotate the MASTER VOLUME CONTROL about half way, clockwise. Rotate the TUNER-MIXER-LEVEL CONTROL until sound is heard; then proceed to tune in a station. The final setting of these controls can now be made, during which the action of the LOUDNESS BALANCE CONTROL will be considered. Because of the automatic feature of this Control, the following considerations should be studied carefully *before proceeding*, as they apply equally to operation of all the channels of the Series 80-C.

At low volume, human hearing does not respond with equal efficiency to *all* frequencies of the audible spectrum. At such volume, hearing follows a definite pattern, losing sensitivity to both low and high frequencies (with respect to the middle register) as the volume level decreases. Since the average listening level is often below that of the original performance, it is necessary that some form of equalization be incorporated to compensate for the resulting loss of balance. Such compensation occurs automatically when the LOUDNESS BALANCE CONTROL is on. Both the low and high frequencies are accentuated by this circuit as the volume is decreased. The amount of accentuation is inversely proportional to the volume setting. For proper use of the LOUDNESS BALANCE CONTROL, a good balance must be established by correct relative setting of the MASTER VOLUME CONTROL and MIXER LEVEL CONTROLS, as against the volume of sound in the room. This depends in large measure on the associated equipment, room acoustics, and one's own taste. A close approximation may be accomplished as follows:

1. Set the MASTER VOLUME CONTROL up one-third.
2. Turn the LOUDNESS BALANCE SWITCH to MAXIMUM (fourth position of switch.)
3. Vary the appropriate MIXER LEVEL CONTROL until the resulting room volume is at approximately the level of the average speaking voice. This setting of the LOUDNESS BALANCE SWITCH affords the maximum amount of low-frequency compensation as well as a small amount of high-frequency correction, as shown in FIGURE 3A.

The third and second positions (clockwise) of the LOUDNESS BALANCE SWITCH provide correspondingly less low frequency compensation and no high frequency correction. The fre-

quency response curves for these switch settings are shown in FIGURES 3B and 3C. With the LOUDNESS BALANCE SWITCH completely counterclockwise (OFF) no compensation takes place and the Model 80-C has conventional, uniform frequency response throughout the audible range for all settings of the MASTER VOLUME CONTROL.

The ultimate setting of these controls must perforce depend on personal taste. It should be noted that setting the MIXER LEVEL CONTROL at a point higher than that suggested will cause a *greater* accentuation of the low and high frequencies for a given room volume. A lower setting will result in *less* accentuation of the low and high frequencies. See FIGURES 3-A, -B, -C.

Figure 3-A. Loudness Balance Control, Maximum Position

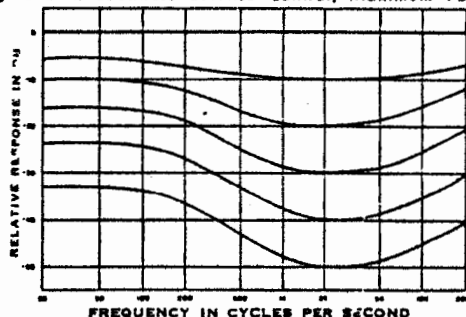

Figure 3-B. Loudness Balance Control, Second Position

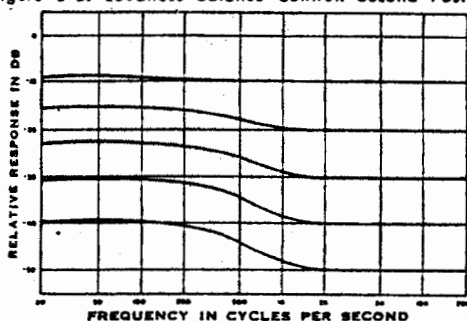
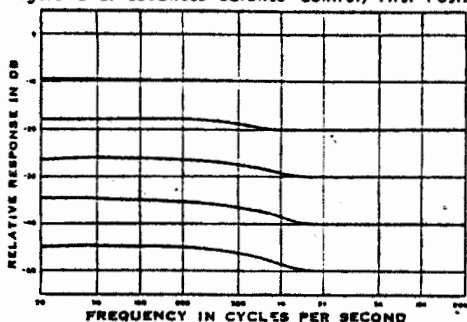
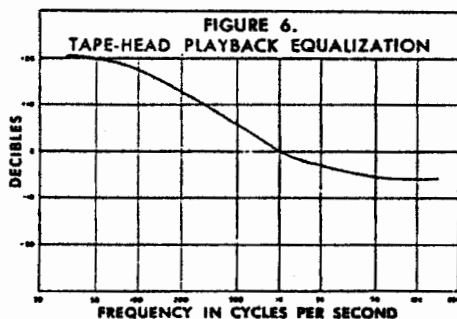

Figure 3-C. Loudness Balance Control, First Position



## TAPE RECORDER PLAYBACK

THE FISHER MASTER AUDIO CONTROL enables the user to listen to the growing library of pre-recorded tapes without having to purchase an expensive complete tape recorder. All that is needed is a commercially available tape transport mechanism incorporating a playback head. The cable from this playback head should be connected directly to the TAPE input jack on the rear apron of the Series 80-C. Press the PHONO CHANNEL SELECTOR BUTTON once again and shift BOTH equalization levers to the TAPE position. This setting connects the playback head to a special tape preamplifier, properly equalized for tape playback in accordance with industry-wide accepted NARTB tape recording standards. See FIGURE 6. Adjust MIXER LEVEL and VOLUME CONTROLS as before. DO NOT connect a complete, self-contained tape recorder to this input. Such recorders are best connected to either one of the two auxiliary high-level inputs.



## ADDITIONAL APPLICATIONS

The two auxiliary inputs on THE FISHER MASTER AUDIO CONTROL are for the audio portion of a TV receiver, the playback output of self-contained tape and wire recorders, additional phono pre-amps, etc. Connect the equipment to the AUX 1 input (if you desire that its AC be automatically switched by the Series 80-C) or to AUX 2. Press the appropriate CHANNEL SELECTOR BUTTON and adjust the MIXER LEVEL CONTROLS as described earlier.

## MIXING FACILITIES

THE FISHER Series 80-C incorporates complete interchannel mixing facilities normally available only in the costliest broadcast consoles. That is, two or more signal sources may be operated simultaneously and their relative amplitudes varied as desired. Thus, a microphone may be used for purposes of narration, while listening to music in the background. Singing voices can be superimposed on instru-

mental recordings and the resultant combination preserved on tape, etc. The tape recordist will find this feature outstanding, because he can now achieve all the effects usually possible only in professional sound recording studios. Mixing is extremely simple with your Series 80-C. Simply press two or more CHANNEL SELECTOR BUTTONS SIMULTANEOUSLY. Individual indicator lights show the channel or channels in use. Mixing, to any degree, is accomplished by varying the MIXER LEVEL CONTROLS of each channel, as required. As many as five channels can be thus blended simultaneously, if desired. An exclusive, self-compensating input impedance circuit enables one to make extreme level changes on one channel without interaction on any other channels in use at the time.

Should you wish to disengage all channels but the TUNER, for example, after mixing two or more channels, simply press the TUNER CHANNEL SELECTOR BUTTON once again and all channels OTHER than TUNER will be released automatically.

## A COMPLETE HOME MUSIC SYSTEM

Careful selection of associated equipment for use with THE FISHER MASTER AUDIO CONTROL will result in a perfectly matched, high fidelity home music system. The extreme flexibility and versatility of THE FISHER MASTER AUDIO CONTROL permits the use of any or all of the components of such a system. Those seeking the ultimate in associated equipment will find it in THE FISHER LABORATORY STANDARD AMPLIFIERS, and THE FISHER FM, AM, and FM-AM TUNERS. Complete specifications are available on request.

## AT YOUR SERVICE

It is the constant desire of Fisher Radio Corporation to have your FISHER equipment give you its best possible performance. Toward that objective, we solicit your correspondence on any special problems that may arise. After you have had an opportunity to familiarize yourself with THE FISHER equipment you purchased, we would appreciate your letting us know how it is meeting your requirements.

**SPECIAL NOTE:** To maintain your equipment at peak performance, may we suggest that you avail yourself of the facilities and factory trained personnel at our Service Department.

## FISHER RADIO CORPORATION

21-21 FORTY-FOURTH DRIVE  
LONG ISLAND CITY 1, NEW YORK

**TONE CONTROLS:** When the **BASS** and **TREBLE** **TONE** Control dots are at the top, the response is uniform throughout the range. Turning either Control to the right boosts the response, turning to the left attenuates the response. The effective range of these controls is shown in **FIGURE 4**. The preferred position of the **TONE** **CONTROLS** will depend on personal taste and the particular program material being played. In your experiments to acquire the 'feel' of the controls, start with the dots in the top position (uniform response.)

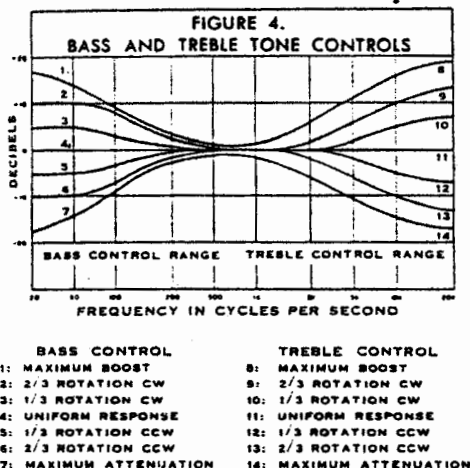

#### PHONOGRAPH OPERATION

In view of the variety of recording characteristics employed by record manufacturers, both the bass and treble frequencies must be properly equalized to match the original recording techniques. Because of the physical limitations of the record groove, frequencies below approximately 500 cycles are recorded with gradually decreasing amplitude as one approaches the lowest frequencies. Conversely, in order to obtain an improved signal-to-noise ratio, treble boost is incorporated. The point at which low frequency attenuation begins, and the amount of high frequency pre-emphasis employed, vary considerably from manufacturer to manufacturer. **THE FISHER MASTER AUDIO CONTROL**, Series 80-C, provides sixteen combinations of equalization for both low and high frequencies. Thus, knowing a given manufacturer's recording characteristics, the user can properly equalize for that recording and achieve optimum balance. A list of recommended settings of the two phono equalization switches for various record manufacturers is on the back page.

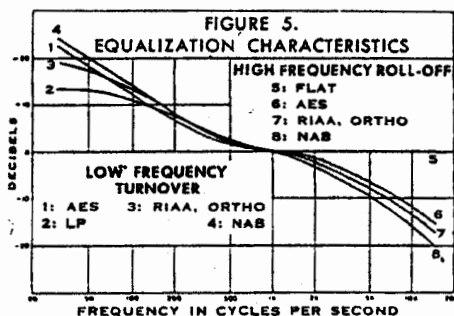

**FIGURE 5** shows the equalization curves available with various settings of the phono equalization switches when using magnetic cartridges. Correct equalization is accomplished as well with ceramic, crystal or constant amplitude cartridges. It should be noted, however, that some of the popular magnetic cartridges presently manufactured require compensation at high frequencies to smooth out their response. For this type of compensation a resistor is normally connected across the cartridge terminals. **THE FISHER MASTER AUDIO CONTROL** obviates the need for this resistor in most cases, because a 47,000 ohm resistor is already wired across the input, making it suitable for use with most GE, Audak, and Fairchild cartridges, without further modification. Most Pickering cartridges should be equipped with an additional 47,000 ohm resistor across its terminals for optimum performance. For other cartridges, we suggest that you check the manufacturer's specifications to determine the loading required to achieve a 'flat' response. Depress the **PHONO SELECTOR BUTTON**, (the **TUNER BUTTON** will be automatically released, turning off that channel as well as the power to the tuner itself) and set **MASTER VOLUME** and **PHONO MIXER LEVEL CONTROLS** as noted under **TUNER OPERATION**.

#### MICROPHONE OPERATION

Most dynamic, crystal or ribbon microphones can be used with **THE FISHER MASTER AUDIO CONTROL** without any additional preamplification. Low impedance microphones require a matching transformer. Simply connect the microphone to the Mic input jack on the rear apron, press the **MIC CHANNEL SELECTOR BUTTON** and adjust the **MIC MIXER LEVEL CONTROL** to give sufficient gain, in conjunction with the **MASTER VOLUME CONTROL**, for the particular application.

# Parts Description List

SYMBOL	DESCRIPTION	PART NUMBER	SYMBOL	DESCRIPTION	PART NUMBER
C-1	Capacitor, Ceramic: 0.01 mfd; 600 V	CK62GP103V6	R-28-A,-I'	Potentiometer, Composition: Dual Vol.-Loudness Control	RS-546-152
C-2	Capacitor, Ceramic: 0.01 mfd; 500 V	CC21GP101M5	R-29-A,-B	Potentiometer, Composition: Dual Tone Control	R-546-106
C-3	Capacitor: .02 mfd; 200 V	C68P203M2	R-30	Resistor, Composition: 100,000 ohms, 10%; 1/2 W	RC20BF108K
C-4	Capacitor: 0.0033 mfd; 10%; 200 V	C68P332K2	R-31	Resistor, Composition: 100,000 ohms, 10%; 1/2 W	RC20BF194K
C-5	Capacitor, Ceramic: 720 mmfd; 10%; 500 V	CC21GP721K5	R-33	Resistor, Composition: 220,000 ohms, 10%; 1/2 W	RC20BF224K
C-6	Capacitor: 0.0022 mfd; 10%; 200 V	C68P222K2	R-34	Resistor, Composition: 2700 ohms, 10%; 1/2 W	RC20BF272K
C-7	Capacitor: 0.047 mfd; 400 V	C68P473M4	R-35	Resistor, Composition: 3300 ohms, 10%; 1/2 W	RC20BF332K
C-8	Capacitor, Ceramic: 0.01 mfd; 600 V	CK62GP103V6	R-36	Resistor, Composition: 470,000 ohms, 10%; 1/2 W	RC20BF474K
C-9	Capacitor: 0.047 mfd; 400 V	C68P473M4	R-37	Resistor, Composition: 2700 ohms, 10%; 1/2 W	RC20BF272K
C-10	Capacitor, Ceramic: 440 mmfd; 10%; 500 V	CC21GP441K5	R-38	Resistor, Composition: 3300 ohms, 10%; 1/2 W	RC20BF332K
C-11	Capacitor, Ceramic: 120 mmfd; 10%; 500 V	CC21GP121K5	R-39	Resistor, Composition: 15 ohms, 10%; 2 W	RC40BF150K
C-12	Capacitor, Ceramic: 220 mmfd; 10%; 500 V	CC21GP221K5	R-40	Resistor, Composition: 47,000 ohms, 10%; 1/2 W	RC20BF473K
C-13	Capacitor: 0.1 mfd; 200 V	C68P104V2	R-41	Resistor, Composition: 3300 ohms, 10%; 1/2 W	RC20BF332K
C-14	Capacitor: 0.02 mfd; 10%; 200 V	C68P203K2	R-42	Resistor, Composition: 100,000 ohms, 10%; 1/2 W	RC20BF104K
C-15	Capacitor, Ceramic: 1000 mmfd; 10%; 500 V	CC26GP102K5	R-43	Resistor, Composition: 10,000 ohms, 10%; 1/2 W	RC20BF108K
C-16	Capacitor, Ceramic: 470 mmfd; 10%; 500 V	CC21GP471K5	R-44	Resistor, Composition: 1 megohm, 10%; 1/2 W	RC20BF105K
C-17	Capacitor: 0.02; mfd; 10%; 200 V	C68P203K2	R-45, R-46	Resistor, Composition: 10,000 ohms, 10%; 1/2 W	RC20BF103K
C-19	Capacitor, Ceramic: 68 mmfd; 10%; 500 V	CC21GP680K5	10-47, R-48	Resistor, Composition: 15,000 ohms, 10%; 1/2 W	RC20BF153K
C-20	Capacitor: 0.1 mfd; 400 V	C68P104M4	S-1, 2, 3, 4, 5	Switch: Push-Button	S-546-118
C-21A,-B,-C,-D	Capacitor, Electrolytic: 40 mfd; 250 V	C-546-115	S-6	Switch: Loudness, part of R-28	S-50022-4
C-22	Capacitor: 0.0047 mfd; 200 V	C68P472M2	S-7	Switch: AC Power, part of R-28	S-50022-5
C-23A,-B	Capacitor, Electrolytic: 1000 mfd; 30 V	C-546-116	S-8	Switch: Lever	S-50022-6
C-24	Capacitor, Electrolytic: 1 mfd; 250 V	C-546-128	S-9	Switch: Lever	SR-3233
C-25	Capacitor, Electrolytic: 25 mfd; 5 V	C-556-137	SR-1	Selenium Rectifier: Full-Wave	SR-3078
C-26	Capacitor, Ceramic: 300 mmfd; 10%; 500 V	CC21GP301K5	SR-2	Selenium Rectifier: Bridge	T-546-114
C-27	Capacitor, Electrolytic: 10 mfd; 300 V	C-546-133	T-1	Transformer: Power	
F-1	Fuse: 8 AG; 1/2 Amp.	F-3297			
I-1, I-2, I-3, I-4, I-5, I-6	Lamp: Panel	I-50009-2			
J-1, J-2, J-3, J-4, J-5, J-6, J-7, J-8, J-9	Jack: 1 female contact	J-3143			
PC-1	Printed Circuit: Tone Control	PC-562-105			
R-1, R-2, R-3	Potentiometer, Composition: 500,000 ohms	R-50000-18			
R-4	Resistor, Composition: 18 megohms, 10%; 1/2 W	RC20BF186K			
R-5	Resistor, Composition: 47,000 ohms, 10%; 1/2 W	RC20BF473K			
R-6, R-7, R-8	Resistor, Composition: 220,000 ohms, 10%; 1/2 W	RC20BF224K			
R-9	Resistor, Composition: 2.2 megohms, 10%; 1/2 W	RC20BF225K			
R-10, R-11	Resistor, Composition: 220,000 ohms, 10%; 1/2 W	RC20BF224K			
R-12	Resistor, Composition: 2700 ohms, 10%; 1/2 W	RC20BF272K			
R-13	Resistor, Composition: 150,000 ohms, 10%; 1/2 W	RC20BF154K			
R-14	Resistor, Composition: 2.2 megohms, 10%; 1/2 W	RC20BF225K			
R-15	Resistor, Composition: 3.3 megohms, 10%; 1/2 W	RC20BF335K			
R-16	Potentiometer, Composition: 500,000 ohms	R-50000-13			
R-17	Resistor, Composition: 2.2 megohms, 10%; 1/2 W	RC20BF225K			
R-18	Resistor, Composition: 220,000 ohms, 10%; 1/2 W	RC20BF224K			
R-19	Resistor, Composition: 2200 ohms, 10%; 1/2 W	RC20BF222K			
R-20	Resistor, Composition: 220,000 ohms, 10%; 1/2 W	RC20BF224K			
R-21	Potentiometer, Composition: 500,000 ohms	R-50000-13			
R-22	Resistor, Composition: 220,000 ohms, 10%; 1/2 W	RC20BF224K			
R-23	Resistor, Composition: 2700 ohms, 10%; 1/2 W	RC20BF272K			
R-24	Resistor, Composition: 220,000 ohms, 10%; 1/2 W	RC20BF224K			
R-25	Resistor, Composition: 330,000 ohms, 10%; 1/2 W	RC20BF334K			
R-26	Resistor, Composition: 47,000 ohms, 10%; 1/2 W	RC20BF473K			
R-27	Resistor, Composition: 10,000 ohms, 10%; 1/2 W	RC20BF103K			

## VOLTAGE MEASUREMENTS

TUBE	PIN NUMBERS								
	1	2	3	4	5	6	7	8	9
V-1, 12AU7	195	115	120	18	18	195	115	118	24
V-2, 12AX7	115	0	1	12	12	115	0	1	18
V-3, 12AX7	150	0	1	6	6	87	—	0	12
V-4, 12AX7	100	0	1	0	0	106	0	1	6

## RESISTANCE MEASUREMENTS

TUBE	PIN NUMBERS								
	1	2	3	4	5	6	7	8	9
V-1, 12AU7	INF	INF	47K	0	0	INF	INF	2.7K	—
V-2, 12AX7	INF	330K	2.7K	—	—	INF	INF	0	—
V-3, 12AX7	INF	400K	2.7K	—	—	INF	18M	2.7K	—
V-4, 12AX7	INF	2.2M	2.7K	—	—	INF	2.2M	—	—

All measurements taken with vacuum tube voltohmmeter. Equipment operated at 117V AC 60 cycles. All resistance measurements taken with respect to chassis. "INF" readings will depend on charging of C-21. Tone Controls set in flat position; Volume Control at zero; Loudness Switch OFF; Mixer Level Controls OFF; all Channel Selectors OUT.



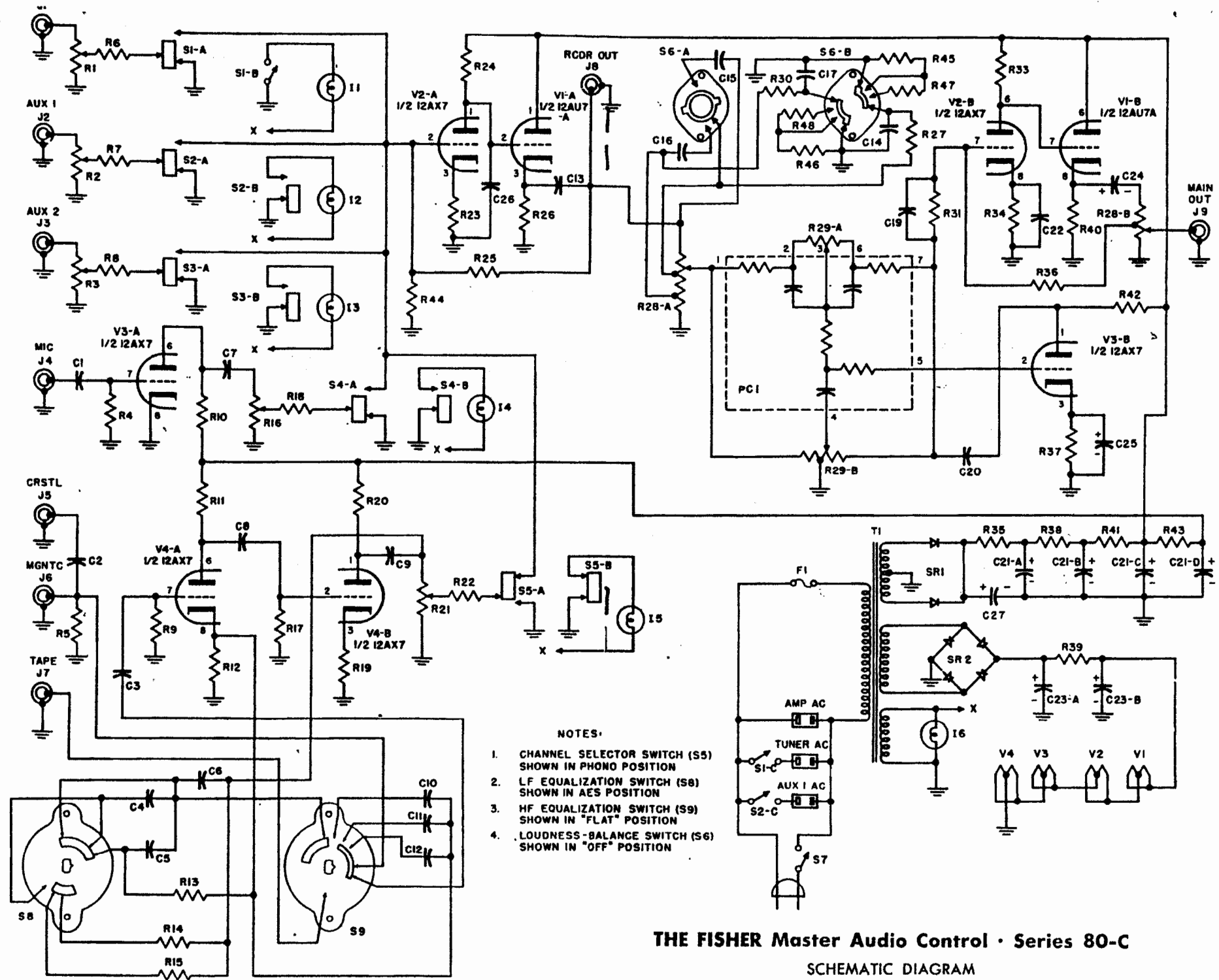

- NOTES:
1. CHANNEL SELECTOR SWITCH (S5) SHOWN IN PHONO POSITION
  2. LF EQUALIZATION SWITCH (S8) SHOWN IN AES POSITION
  3. HF EQUALIZATION SWITCH (S9) SHOWN IN "FLAT" POSITION
  4. LOUDNESS-BALANCE SWITCH (S6) SHOWN IN "OFF" POSITION

**THE FISHER Master Audio Control · Series 80-C**  
SCHEMATIC DIAGRAM

## RECORD EQUALIZATION GUIDE

MANUFACTURER	LOW FREQUENCY TURNOVER	TREBLE ROLL-OFF AT 10 KC	MANUFACTURER	LOW FREQUENCY TURNOVER	TREBLE ROLL-OFF AT 10 KC
ALLEGRO	LP	NAB	HAYDN SOCIETY*	LP	NAB
ALLIED	RIAA	RIAA	HMV-AMER	AES	AES
AMERICAN REC. SOCIETY*	NAB	RIAA	HMV-ENGLISH	LP	NAB
ANGEL	RIAA	RIAA	L'OISEAU-LYRE*	LP	AES
ATLANTIC*	NAB	NAB	LONDON*	LP	AES
BACH GUILD	LP	NAB	LYRICHORD*	NAB	NAB
BANNER	LP	NAB	MERCURY*	AES	AES
BARTOK	NAB	NAB	MGM	RIAA	RIAA
BLUE NOTE*	AES	AES	MONTILLA	RIAA	RIAA
BOSTON*	LP	NAB	NEW RECORDS	LP	NAB
CAEDMON	NAB	AES	OCEANIC*	LP	NAB
CANYON*	AES	AES	OXFORD	LP	NAB
CAPITAL*	AES	AES	PACIFIC JAZZ	RIAA	RIAA
CAPITOL-CETRA	AES	AES	PERIOD	NAB	NAB
CETRA-SORIA	LP	NAB	PHILHARMONIA*	AES	AES
COLOSSEUM*	LP	NAB	POLYMUSIC*	NAB	NAB
COLUMBIA*	LP	NAB	RACHMANINOFF SOCIETY	LP	AES
CONCERT HALL*	AES	AES	RCA VICTOR	ORTHO**	ORTHO**
COOK	NAB	AES	REMINGTON*	NAB	NAB
CONTEMPORARY*	AES	AES	RENAISSANCE	LP	AES
CORAL*	AES	AES	RIVERSIDE	RIAA	RIAA
DECCA*	AES	AES	ROMANY	RIAA	RIAA
DIAL	LP	NAB	SAVOY	RIAA	RIAA
ELEKTRA	NAB	NAB	STRADIVARI	LP	NAB
EMS*	AES	AES	TEMPO	RIAA	RIAA
EPIC*	LP	NAB	URANIA*	LP	NAB
ESOTERIC	RIAA	RIAA	VANGUARD*	LP	NAB
FESTIVAL	LP	NAB	VOX*	LP	NAB
FOLKWAYS	NAB	NAB	WALDEN	RIAA	RIAA
GOOD TIME*	AES	AES	WESTMINSTER	RIAA	RIAA
HANDEL SOCIETY	LP	NAB			

\* Beginning sometime in 1954 records made from new masters require RIAA equalization for both bass and treble.

\*\* The Orthophonic equalization is identical to the RIAA.