

TABLE OF CONTENTS

GENERAL DESCRIPTION _____	1
TECHNICAL DESCRIPTION _____	1
Mechanical Specifications_____	2
Electrical Specifications_____	2
FRONT PANEL FACILITIES _____	2
INSTALLATION _____	5
CONNECTING _____	6
A-C Connections_____	6
Input Connections_____	7
Output Connections_____	9
Ground Connections (Program Sources)_____	9
OPERATING INSTRUCTIONS _____	10
Balancing a Stereo System_____	10
To Adjust for Balance in the Treble Range_____	10
To Adjust for Amplitude Balance in the Bass Range_____	10
Adjusting Phase_____	10
Listening to a Stereo Record_____	10
To Adjust the Balance Control After the System has been Balanced_____	11
Adjusting for Special Effects_____	11
Using the C20 with a Stereo Tuner_____	11
Using the C20 with a Stereo Tape Machine_____	11
Using the C20 Front Panel Tape Jacks_____	12
Using the C20 with Tape Decks_____	12
Using the C20 with Microphones for Stereo. Monophonic Record Settings_____	12
Operating Curves_____	14
GUARANTEE _____	16



OWNER'S MANUAL

C20 STEREOPHONIC PREAMPLIFIER

GENERAL DESCRIPTION

The McIntosh C20 Stereophonic Pre-amplifier is a control center for any stereophonic sound system. This control center is necessary to accurately perform four specific functions to increase the enjoyment of stereo.

First, the control center amplifies weak electrical impulses. As the record rotates on the turntable, undulations in the grooves move the pick-up stylus approximately one-thousandth of an inch, in any direction, from the rest position. From this slight mechanical movement, the pick-up stylus generates a weak electrical impulse on the order of a few thousandths of a volt. To amplify and preserve the character of such an electrical impulse, the finest amplifier performance is required.

Second, every sound system is used in a different acoustical environment. The tone balance of the music

is affected by variations in environment. Also, people listening to the music have varying ideas of correct tone balance. To adequately compensate for these conditions, a high-quality control center is needed.

Third, there is a great variety of stereophonic and monophonic records manufactured today, both domestic and foreign. The control center must provide record compensation for a great variety of recordings.

Fourth, with programs originating from a variety of sources such as tuners, records, tape machines, microphones, etc., a control center is needed to select and switch these sources separately or in combination.

All of these jobs are performed with excellence by the C20 and yet this instrument is easy to mount, simple to operate, and is the finest in appearance.

TECHNICAL DESCRIPTION

You now own the finest expression of stereo craftsmanship . . . designed and built to fulfill your needs. Through direct consumer contact, a unique McIntosh marketing research program determines the application of electronic and mechanical engineering to fit your needs. Relentless research by McIntosh engineers improves the selection of materials and the circuits in which they are used. It is this total concept of craftsmanship directed to consumer satisfaction that has maintained the McIntosh reputation for excellence in performance, quality, and reliability.

Perhaps you would like to know a few of the features developed through research based on consumer needs that place your C20 Pre-amplifier above all other pre-amplifiers.

An example of the unique mechanical construction throughout is emphasized on the back panel where low-voltage program sources are connected to the C20. This portion of the panel is cut out and mounted on small electrical insulators. The ground circuit is connected to the main chassis at only one point. By breaking the path for circulating hum currents in this manner, the hum and unwanted noises induced in other stereo systems when used with various program sources and combinations of program sources are eliminated.

Hum noises are also introduced into stereo systems by the magnetic fields produced by the power transformer windings. The greatest care went into the design and construction of the power transformer in your C20. It is wound in such a way that the magnetic fields produced by the windings tend to cancel. This is accomplished by splitting the windings into two segments. Further reduction of the magnetic field intensity is achieved through the use of additional magnetic and electrical shielding. With these construction improve-

ments the hum noises introduced by ordinary pre-amplifiers are eliminated by the C20.

Nearly all of the small resistor and capacitor component parts in the C20 are mounted on military-type terminal boards. This specialized construction prevents damaging mechanical strains. In addition it makes servicing, if ever required, much easier and more effective.

The mechanical layout of the C20 allows maximum separation of the left and right channels. The terminal board at the rear of the C20 is associated with the right channel and the terminal board at the front with the left channel. C20 terminal boards are constructed of natural bakelite because of its low-volume resistivity. This prevents the gradual increase of electrical noise common to other terminal board materials after continued use of the control center.

The C20 is the only control center that has an illuminated front panel to provide convenient reading under low-level lighting conditions. This feature is of particular importance when a closet is adapted to house stereo equipment.

Front panel tape input jacks are another exclusive feature provided by the C20. With the start of stereo FM broadcasting it will be important to tape and preserve those special programs that will otherwise never be heard again. This feature will be greatly appreciated by you and your friends when recording on portable tape machines.

Only extensive research and planning combined with skilled engineering and manufacturing knowhow, directed toward consumer needs, can produce such a fine electronic instrument.

MECHANICAL SPECIFICATIONS

DIMENSIONS

Chassis: 14-1/2 inches wide; 4-1/2 inches high; 12 inches deep
 Front Panel: 15-5/8 inches wide; 4-7/8 inches high
 Front Panel Mounting Space Required: 16-3/8 inches wide; 5 inches high

WEIGHT

Chassis: 18 pounds
 Shipping Weight: 28.5 pounds

FINISH

Anodized gold and black (front panel)

ELECTRICAL SPECIFICATIONS

POWER REQUIREMENTS

117 volts, 50/60 cycles, ac, 35 watts

INPUT SENSITIVITY AND INPUT IMPEDANCE

Auxiliary: 0.25 volt; 470,000 ohms
 Tape: 0.25 volt; 470,000 ohms
 Tuner 1: 0.25 volt; 470,000 ohms
 Tuner 2: 0.25 volt; 470,000 ohms
 Phono 1: 2 to 10 millivolts; 47,000 ohms for low-output cartridge
 10 to 70 millivolts; 47,000 ohms for high-output cartridge
 0.1 volt; 220 mmf in series with 47,000 ohms for Xtal or ceramic cartridge
 Phono 2: Same as phono 1
 Tape Head 1: 2 to 10 millivolts; 47,000 ohms for low-output head
 10 to 70 millivolts; 267,000 ohms for high-output head
 Tape Head 2: Same as tape head 1
 Tape Compare (Monitor): 0.25 volt; 115,000 ohms

FREQUENCY RESPONSE

±0.5db, 20 to 20,000 cycles

DISTORTION

Less than 0.2% at rated output, 20 to 20,000 cycles

HUM AND NOISE

High-level inputs: 85 db below rated output

Low-level inputs: less than 2 microvolts at input terminals

MAIN OUTPUT

2.5 volts with rated input
 2 output jacks in parallel for each channel

TAPE OUTPUT

0.25 volt with rated input
 1 output jack for each channel

LEFT PLUS RIGHT OUTPUT

2.5 volts from generator impedance of 23,000 ohms

VOLTAGE AMPLIFICATION

Low-level inputs to Main Output: 1,000 to 1 (60 db) at 1000 cycles
 Low-level inputs to Tape Output: 100 to 1 (40 db) at 1000 cycles
 High-level inputs to Main Output: 10 to 1 (20 db)
 High-level inputs to Tape Output: 1 to 1 (0 db)
 Tape Compare (Monitor) input to Main Output: 10 to 1 (20 db)

A-C AUXILIARY OUTLETS

1 unswitched for tape machine or turntable, colored Red
 4 switched, colored Black

FRONT PANEL FACILITIES

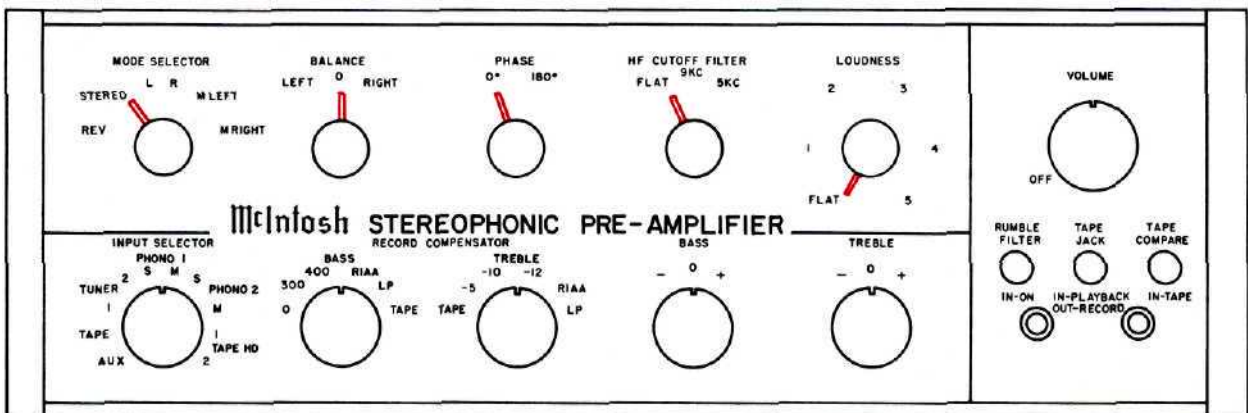
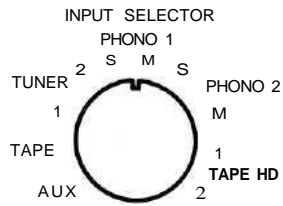

Figure 1. C20 Front Panel

INPUT SELECTOR



This ten-position program switch connects the C20 as follows:

AUX ... any auxiliary service, such as a television set, an extra tuner, or any other program source requiring flat amplification.

TAPE ... any self-contained tape machine (tape machine having its own playback preamplifier).

TUNER 1 & 2 ... AM and FM outputs from a stereo tuner or a pair of stereo tuners.

PHONO 1 & 2 — S & M ... stereo or monophonic operation with the following types of phono cartridges.

- Constant amplitude cartridges such as crystal, ceramic, or frequency-modulated devices.
- Magnetic cartridges having an output of 10mv or more. Maximum input voltage for this output is 70mv.
- Magnetic cartridges having an output of less than 10mv.

TAPE HEAD—1 & 2 ... a tape deck or a pair of tape decks that do not contain their own playback preamplifiers. Two types of tape head outputs can be used in this position.

- Tape heads having an output of less than 10mv.
- Tape heads having an output of 10mv or more. Maximum input voltage for this output is 70mv.

MODE SELECTOR

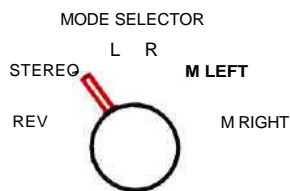

This six-position switch connects the C20 for proper left-right distribution of sound for the program source selected. Its positions are as follows:

REV ... connects left channel to right speaker, right channel to left speaker, corrects for left-right reversal of program.

STEREO ... this is the normal stereo MODE SELECTOR position; left channel to left speaker, right channel to right speaker.

L ... left channel to left speaker, no program to right speaker.

R ... right channel to right speaker, no program to left speaker.

M LEFT ... left channel only to both speakers.

M RIGHT ... right channel only to both speakers.

RECORD COMPENSATOR

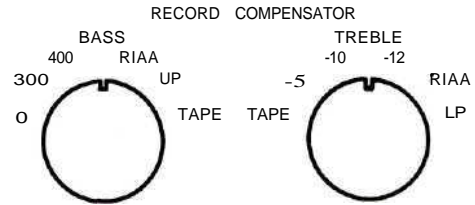

These controls are used to correct for program equalization introduced by the recording process. Table 3 gives the recommended settings of the RECORD COMPENSATOR controls of the C20 for monophonic recordings.

BASS AND TREBLE

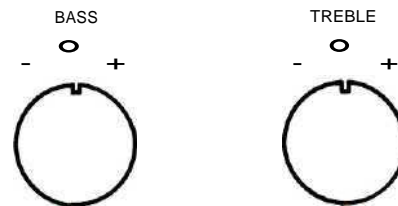

There are two tone controls on the C20—BASS and TREBLE.

BASS ... clockwise rotation increases bass loudness; counterclockwise rotation decreases bass loudness.

TREBLE ... clockwise rotation increases treble loudness; counterclockwise rotation decreases treble loudness.

PHASE

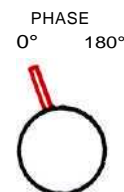

This two-position switch reverses the phase in the left channel to correct for speaker or program phasing.

BALANCE

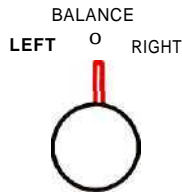

This control balances the C20 for unequal program sources.

LEFT . . . turning the control to the left slowly reduces the right channel to no output and accents the left channel.

RIGHT . . . turning the control to the right slowly reduces the left channel to no output and accents the right channel.

HF CUTOFF FILTER

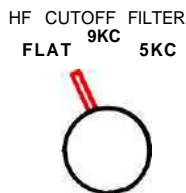

This three-position switch minimizes surface noise when reproducing old, badly worn recordings. Its positions are as follows:

FLAT... filter disconnected.

9KC . . . rolls off response sharply starting at 9KC.

5KC . . . rolls off response sharply starting at 5KC.

LOUDNESS

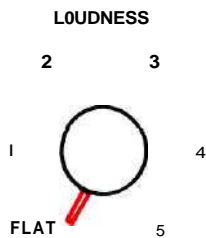

Music reproduced at very low volume loses its bass and treble due to a selective shift in sensitivity of human hearing. This effect is known as the Fletcher-Munson hearing characteristics. (See page 15, Figure 13.) The LOUDNESS control corrects for this effect.

RUMBLE FILTER



With the RUMBLE FILTER button pushed to the IN position, low-frequency rumble noise below 60 cps created by a turntable or changer and undesirable acoustically coupled feedback are reduced.

TAPE JACK

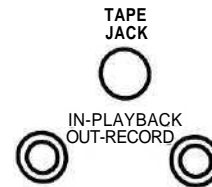

This pushbutton controls the signal direction to or from the front panel telephone jacks.

IN-PLAYBACK . . . TAPE input is switched from rear tape jacks to front panel telephone jacks.

Any program originating from a portable machine connected to the C20 can be heard by rotating the INPUT selector to the TAPE position.

OUT-RECORD . . . connect signals from the rear tape jacks to the INPUT SELECTOR TAPE position. Any program picked up by the C20 is connected to the portable machine for recording,

TAPE COMPARE



This pushbutton makes it possible to instantaneously compare the recorded material with the source signal. TAPE COMPARE jacks are provided on the back panel to accept a signal- from a tape recorder with a monitor head and preamplifier. When the TAPE COMPARE pushbutton is in the out position, the program source is fed through the power amplifiers and the loudspeakers. When the TAPE COMPARE pushbutton is in the IN position (depressed), the signal source becomes the monitored program from the recorded tape and is fed through the power amplifiers and loudspeakers.

IMPORTANT

When the TAPE COMPARE pushbutton is depressed, signal from any other source will not be heard from the loudspeakers. When not in use, make sure the pushbutton is in the out position.

VOLUME

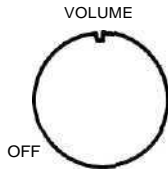

The combined VOLUME control and OFF-on switch controls the volume for both channels and switches line power to four black receptacles on the back panel.

LOW FREQUENCY TRIM

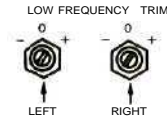

These controls, located on the back panel, compensate for unequal speaker response at low frequencies due to location of speakers in a room or differences in speaker efficiency. It provides 6db boost at 50 cycles starting from 500 cycles or 8db cut at 20 cycles starting from 200 cycles.

INSTALLATION

The C20 can be installed in conventional cabinets, custom built-ins, or professional equipment racks. If the unit is to be placed on a shelf or table-top, it is recommended that it be housed in a McIntosh Model L-66 cabinet. Install the C20 from the front of the cabinet; not from the rear.

When mounting the C20 the minimum thickness of wood panel should be 1/4" in order to support the weight. Panels up to 1" thickness may be used. If the front panel of a cabinet is made of wood, to prevent warping a shelf is required to support the rear of the chassis. When mounted on a metal rack panel, a shelf is not needed.

The C20 installation should allow at least 13-3/4" behind the front panel to allow about 1-1/2" for connectors. The desirable width and height are, 16-1/2" and 5-1/2", respectively, so there* will be sufficient space for circulation of air. These are inside dimensions. The front panel mounting space width and height are 16-3/8" and 5", respectively.

MAKING THE FRONT PANEL CUTOUT

The panel is cut out using the "FRONT PANEL CUTOUT TEMPLATE." To position the template on the front of the panel, make two locating holes from the back (inside) of the panel using one of the mounting strips (1/2" by 3-1/2") as a measuring tool. Proceed as follows:

Determine the exact center of the proposed cutout area. Scribe a vertical center line from the top of the panel to the top surface of the shelf as illustrated in "A", Figure 2. Using one of the mounting strips as a measuring tool, draw a horizontal line 3-1/2" above the shelf. (See "B", Figure 2.) Place a mounting strip along the horizontal line to the left of the vertical center line and mark a point 3-1/2" left from the vertical center line. Repeat this procedure and mark a point 3-1/2" to the right of the vertical center line. These points should now be 3-1/2" up from the top of the shelf and 7" apart, one 3-1/2" to the left and one 3-1/2" to the right of the vertical center line. (See "C", Figure 2.) Drill a 3/16" hole at each point. Hold the drill perpendicular to the panel so that the hole will be located accurately on the front of the panel.

Position the template on the front of the panel using the two locating holes to line it up correctly. Scribe the rectangular opening on the front panel and mark the position of the six mounting holes. Drill the six 3/16" mounting holes before cutting the panel opening. Then cut out the opening. It is important that the cutout be just within the lines.

SHELF MOUNTING

If the installation requires a shelf, proceed as

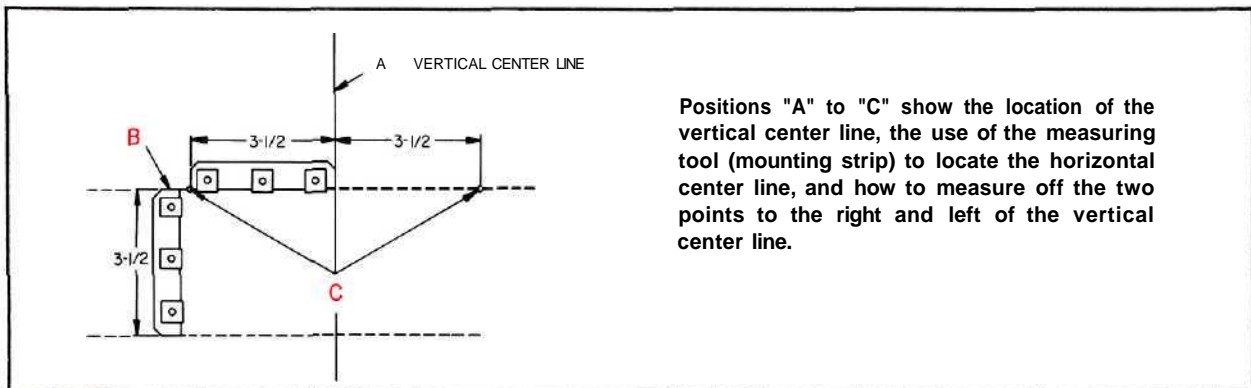

Positions "A" to "C" show the location of the vertical center line, the use of the measuring tool (mounting strip) to locate the horizontal center line, and how to measure off the two points to the right and left of the vertical center line.

Figure 2. Cutout Measurements

follows: Locate the center of the shelf and scribe a line from front to back. The "SHELF CUTOUT TEMPLATE" is marked for panel thicknesses from 1/4" to 1". Fold the template on the line that corresponds to the thickness of the panel. Place it on the shelf so that it butts against the inside of the panel. Match the center line mark on the template to the scribed center line on the shelf. Mark the position of the four drill holes. Drill the four 1/4" holes.

INSTALLING THE C20

Remove the four screws holding the C20 to the shipping pallet. (Save these screws, you will need them if your cabinet has a 1/4" or 3/8" shelf.) Remove the four plastic feet from the bottom of the C20.

In the mounting hardware package are four 6-32 flathead screws and eight 6-32 roundhead screws. Two of the flathead screws of the proper length are used to attach the mounting strips to the cabinet. Four of the roundhead screws of the proper length are used to attach the C20 to the cabinet and mounting strips. The 6-32 x 1/2" screws are to be used with panels under 3/8" in thickness. The 6-32 x 1-1/4" screws are to be used with panels 1/2" to 1" in thickness.

Select the proper length 6-32 flathead screws and use them to install the two mounting strips behind the front panel. Be sure that the edge of the strip with the clips is toward the panel opening. Line up the mounting strips on each side of the front panel cutout so the three holes in the strip are in line with the three holes in the panel. (See Figure 3.) Install the proper length flathead screws in the center hole of each strip. Drive them in so the flatheads are flush with the panel; if necessary, countersink the two center holes.

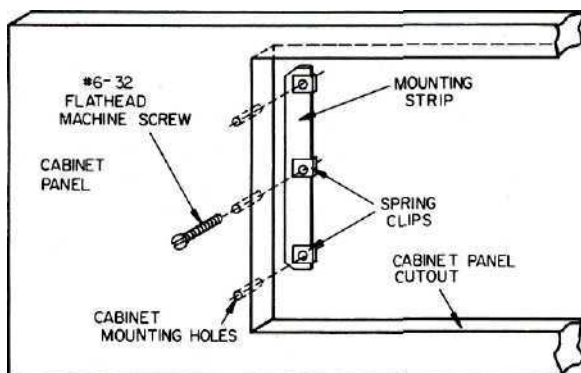

Figure 3. Securing the Mounting Strip to the Front Panel

Carefully insert the C20 through the front of the panel opening so that it rests on the shelf. Insert the proper length 6-32 roundhead screws into the four holes in the mounting flanges on each end of the tuner front panel. Drive them in, but do not tighten.

If the cabinet is fixed and will not be moved about, it is not necessary to secure the C20 chassis to the shelf. If the cabinet is to be moved about, it is recommended that the C20 chassis be secured to the shelf in the following manner. Tighten the four screws holding the front panel. The four 10-32 x 1/2" screws used in shipping are supplied for use if the shelf is under 3/8". Use the 10-32 x 3/4" screws if the shelf is 1/2" or 5/8" and the 10-32 x 1" screws if the shelf is 3/4" or 7/8". Secure the chassis with the proper length 10-32 machine screws, inserting them from beneath the shelf. Do not tighten the 10-32 screws until you have tightened the front panel screws.

Attach the two metal panel end caps (packed with mounting hardware) on each end of the panel by sliding onto the pins. (See Figure 4.) The end caps are held by spring tension and can easily be removed if the chassis is to be taken out of the cabinet.

Use of the wrong length 10-32 screws may cause electrical shorting in the circuit.

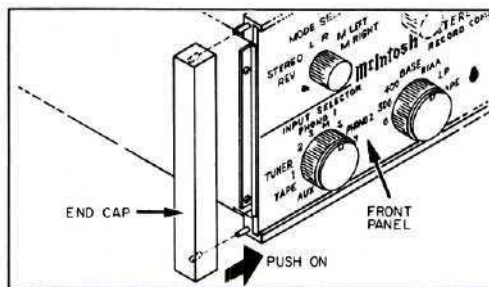

Figure 4. Fitting of Panel End Caps to Panel

MOUNTING IN THE L-66 CABINET

The McIntosh L-66 cabinet is supplied with complete instructions and all necessary hardware for installing the C20. The dimensions of the L-66 are 16-9/16" wide by 6-11/16" high, including mounting feet, by 13-3/4" deep, including the front panel and control knobs.

CONNECTING

A-C CONNECTIONS

There are five a-c receptacles in the lower left-hand corner of the rear panel. (See Figure 5.) These receptacles have a maximum rating of 600-watt total. The four black receptacles are controlled by the OFF-on switch on the VOLUME control. The red receptacle

is not switched. The red receptacle is used for powering a turntable or record changer. The receptacle is not switched so that the turntable power will not be turned off while the turntable idler wheel is engaged. With this arrangement it is necessary to turn off the turntable with its own control switch so that no damage will result to the turntable drive system.

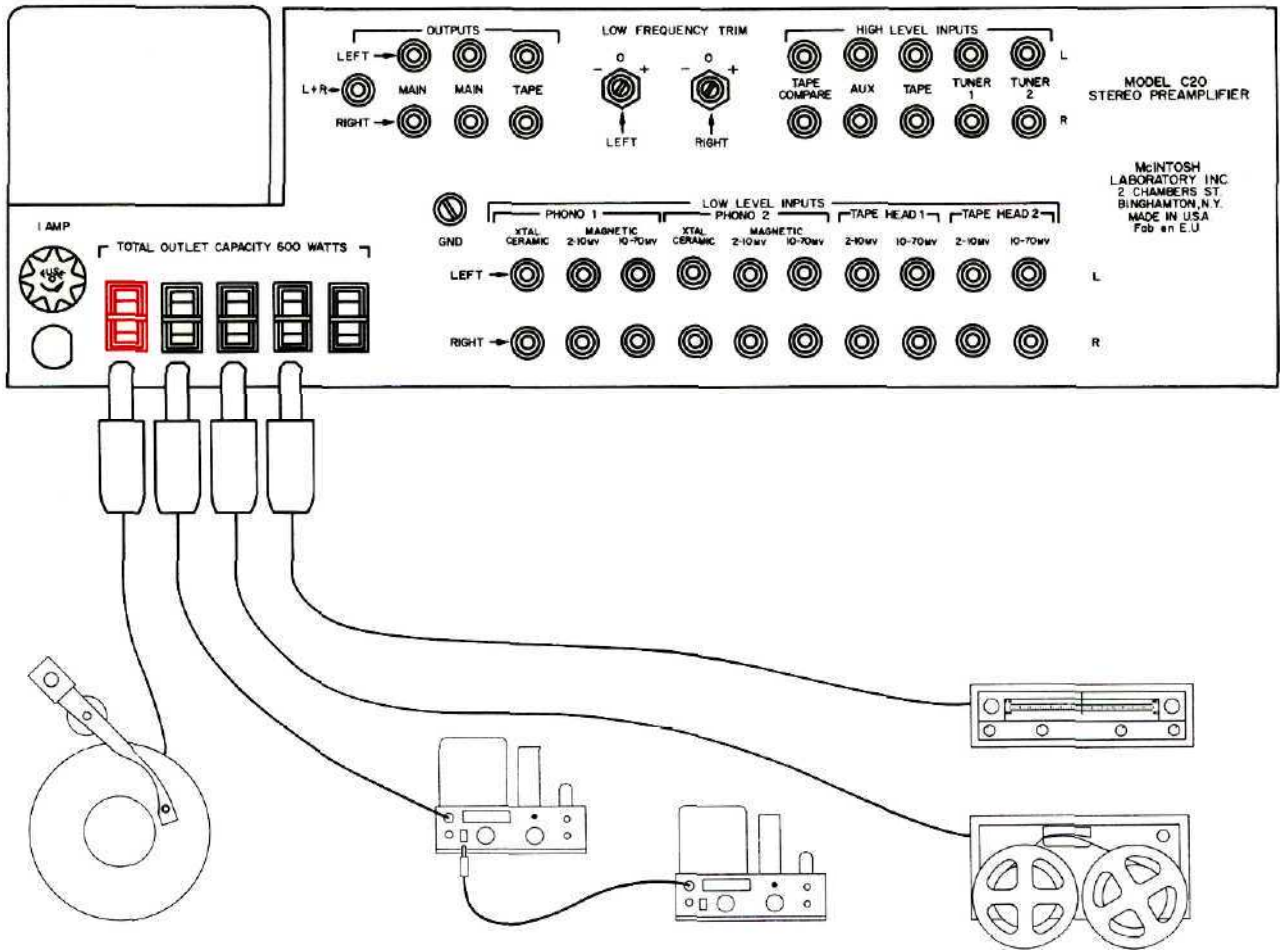

Figure 5. C20 Back Panel

INPUT CONNECTIONS

The C20 provides eight separate program inputs controlled by the INPUT SELECTOR switch, one input for tape comparison or monitor controlled by the TAPE COMPARE pushbutton, and a pair of telephone jack

inputs located on the front panel and controlled by the TAPE JACK pushbutton.

The input program connection should be made in accordance with Tables 1 and 2.

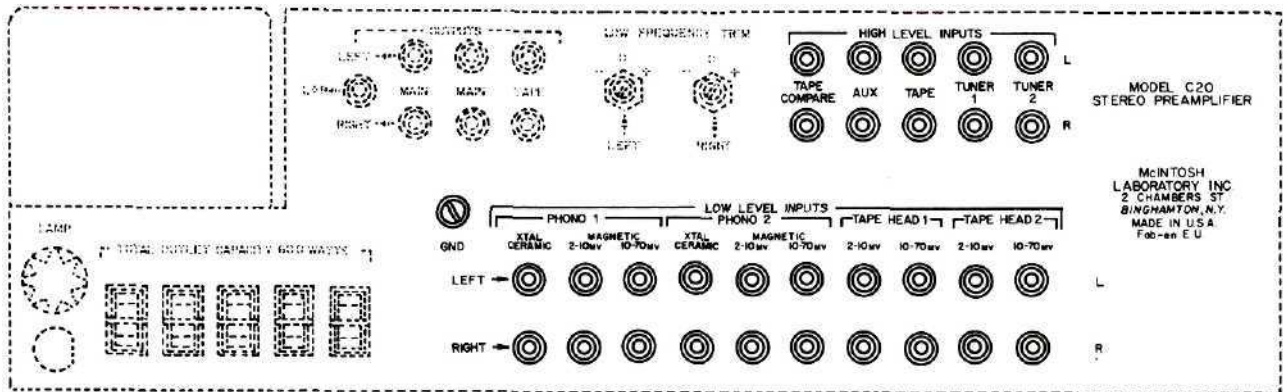

Figure 6. C20 Input Connections (Back Panel)

Table 1. High-Level Input Connections

CONNECTION	FUNCTION	INPUT SENSITIVITY	INPUT IMPEDANCE
TAPE COMPARE	The tape compare input accepts a signal from a tape recorder with a monitor head and pre-amplifier.	0.25V	115K
AUX	The auxiliary input accepts any auxiliary service requiring flat frequency response, such as a T.V. set, tuner, tape recorder with its own playback pre-amplifier, etc.	0.25V	470K
TAPE	The tape input operates with tape machines containing their own playback pre-amplifier.	0.25V	470K
TUNER 1 & TUNER 2	The tuner inputs accept AM and FM outputs from a stereo tuner or a pair of stereo tuners.	0.25V	470K

Table 2. Low-Level Input Connections

CONNECTION	FUNCTION	SENSITIVITY	IMPEDANCE
TAPE HEAD 1 & 2 2-10 MV	These jacks are to be used with a tape deck or a pair of tape decks that do not contain their own playback pre-amplifiers and have an output of less than 10 MV.	2 MV	47K
TAPE HEAD 1 & 2 10-70 MV	These jacks are to be used with a tape deck or a pair of tape decks that do not contain their own playback pre-amplifiers and have an output of more than 10 MV.	10 MV	267K
PHONO 1 & 2 XTAL CERAMIC	These jacks are to be used with a constant amplitude cartridge such as a crystal, ceramic, or frequency-modulated device.	0.1 V	220 mmf in series with 47K
PHONO 1 & 2 MAGNETIC 2-10 MV	These jacks are to be used with magnetic cartridges having an output less than 10 MV.	2 MV	47K
PHONO 1 & 2 MAGNETIC 10-70 MV	These jacks are to be used with magnetic cartridges having a relatively high output. Maximum input voltage for this input is 70 MV.	10 MV	47K

If a cartridge requires less than 47,000 ohms load impedance, a resistor can be added across the

terminals of the cartridge to achieve the correct termination. The following chart may be used as a guide:

Desired Impedance

- 47,000 ohms (47K)
- 37,000 ohms (37K)
- 27,000 ohms (27K)
- 15,000 ohms (15K)
- 6,800 ohms (6.8K)

Resistor Across Input

- No Resistor
- 180,000 ohms (180K)
- 62,000 ohms (62K)
- 22,000 ohms (22K)
- 8,200 ohms (8.2K)

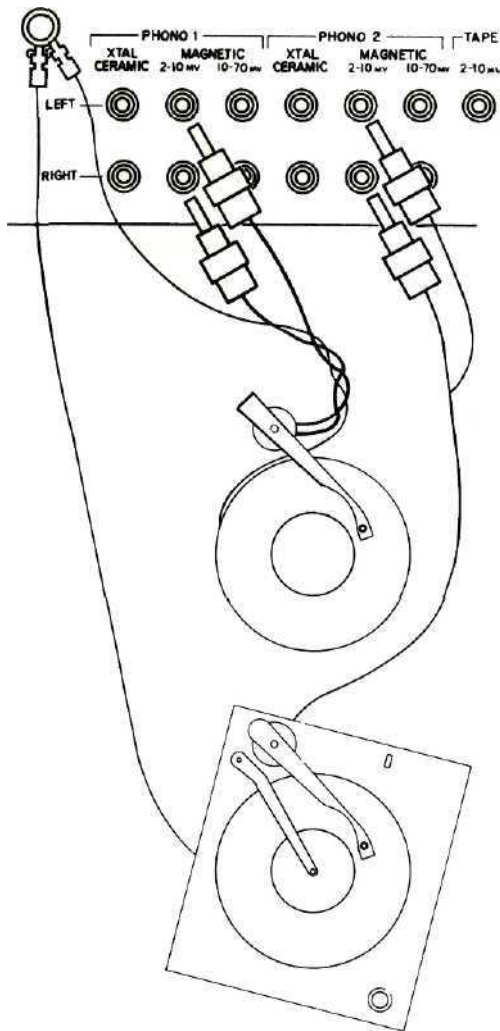

Figure 7. Turntables Feeding Low Level Input.

OUTPUT CONNECTIONS

Two sets of outputs, located in the upper left-hand corner of the back panel, are provided. (See Figure 8.)

The MAIN output connects to power amplifiers (Figure 9) and the TAPE output to feed a tape recorder.

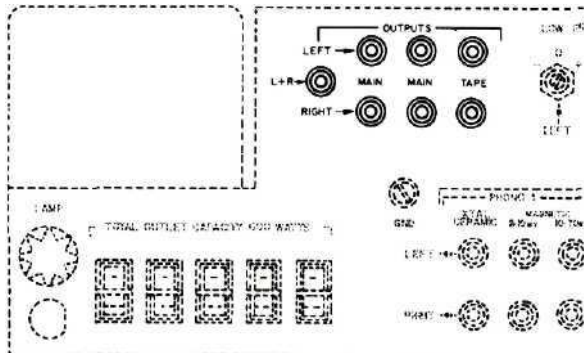

Figure 8. Output Connections

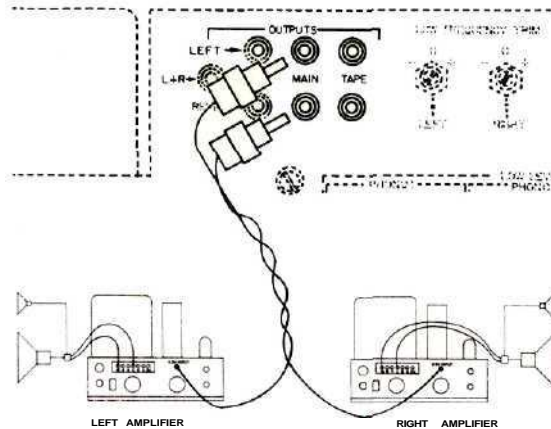

Figure 9. MAIN Output Connected to Power Amplifiers

The MAIN and TAPE output jacks are fed from cathode followers. The input impedance of devices connected to these outputs should be 50,000 ohms or greater, and the capacitive reactance of audio cables connecting these devices should not be less than 8,000 ohms at 20,000 cycles. This is the reactance of a capacity of 1,000 mmf. Audio cable having a capacity of 25 mmf per foot may be 40 feet long; 13.5 mmf per foot cable may be 75 feet long.

The TAPE OUTPUT is unaffected by any adjustments made with the following controls: MODE SELECTOR, BALANCE, PHASE, LOUDNESS, BASS, TREBLE, RUMBLE FILTER and VOLUME. Any adjustments made in the INPUT SELECTOR, RECORD COMPENSATOR, and the HF CUTOFF FILTER will affect the signal at the TAPE OUTPUT jacks if the signal originates in the phono or tape heads inputs.

C20 Preamplifiers, Serial No. 6L700 and later, have an additional left plus right output jack. A monophonic signal can be distributed to other rooms by connecting this jack to a power amplifier to drive the monophonic loudspeakers. The cable connecting to this output should not have a capacity of more than 30mmf. The input impedance of the power amplifier connecting to this output should not be less than 150,000 ohms (150K). The generator impedance at this output is approximately 23,000 ohms (23K).

GROUND CONNECTION (PROGRAM SOURCES)

A single ground post is provided. The chassis ground from turntable, record changers (motors used with each), tape decks, etc., should be returned to this post. Do not duplicate this ground circuit. Undesirable hum is likely to be heard in the system if duplicate ground returns are used.

The left and right program cables from each source should be twisted together and the ground wire from each source can be wound or twisted in with these cables. To avoid hum, make sure the ground wire does not make any connections to shields of the left and right channel cables except for the connection provided with the C20 ground post.

OPERATING INSTRUCTIONS

BALANCING A STEREO SYSTEM

The ultimate in stereo performance and listening enjoyment is obtained through the proper balancing of the stereo system. A properly balanced stereo system must be in phase. Each channel must be equal in loudness and similar in frequency response. When the proper balancing of the McIntosh Model C20 Stereophonic Pre-amplifier is accomplished, the stereo system will remain balanced throughout all modes of operation.

To properly balance the McIntosh C20 proceed as follows: A familiar recording, either stereo or monophonic, should be used in balancing the stereo system.

1. Turn the INPUT SELECTOR to PHONO 1 M.
2. Turn each RECORD COMPENSATOR control to RIAA.
3. Turn the BASS and TREBLE controls to 0.
4. Turn the MODE SELECTOR to STEREO.
5. Turn the BALANCE and PHASE controls to O.
6. Turn the HF CUTOFF FILTER to the FLAT position.
7. Turn the LOUDNESS control to FLAT.
8. With the controls set in this manner, a monophonic signal of equal amplitude will be fed to each side of the pre-amplifier.

TO ADJUST FOR AMPLITUDE BALANCE IN THE TREBLE RANGE

Do not use the C20 BALANCE control for this procedure. The C20 BALANCE control is used to adjust for any unbalance in the source material, the phono cartridge, and the tape machine.

1. Adjust the BASS tone control to its full counterclockwise position.
2. While the recording is playing, alternate the MODE SELECTOR between L and R positions. Adjust the gain control on the input to the power amplifier until the loudspeakers are of equal loudness.

When using the McIntosh MC240 Twin 40 Watt or MC275 Twin 75 Watt Dual Stereo Power Amplifier and connecting the C20 to the stereo input jacks, merely rotate the BALANCE control on the MC240 or MC275 until the loudspeakers are of equal loudness.

TO ADJUST FOR BALANCE IN THE BASS RANGE

1. Adjust the TREBLE tone control to its extreme counterclockwise position.
2. Adjust the BASS tone control to its extreme clockwise position. For an additional boost, if desired,

rotate RECORD COMPENSATOR control marked BASS to the TAPE position.

The music will have an unnatural tone balance during this procedure. The bass sound will predominate. In some installations it may be necessary to reduce the volume to prevent acoustical feedback.

3. Switch the MODE SELECTOR between L and R and listen carefully to the low-frequency response.
4. Adjust the LOW FREQUENCY TRIM controls on the back panel and establish balance by advancing the controls, one more than the other.

The LOW FREQUENCY TRIM controls are independent of the front panel tone controls and will adjust only the low-frequency balance. This arrangement leaves the front panel controls free to correct over-all tone balance in the program, correcting for recording or playback environment.

If your loudspeakers produce more than adequate bass response when the C20 is adjusted for normal playback, turn both LOW FREQUENCY TRIM controls fully counterclockwise. Then bring the system into balance by advancing only the trim control corresponding to the loudspeaker producing less bass response.

If your loudspeaker systems produce less bass response than you desire, the LOW FREQUENCY TRIM controls may be turned fully clockwise. The system is then brought into balance by reducing the bass response on the loudspeaker producing the greater bass amplitude.

ADJUSTING PHASE

1. Rotate both RECORD COMPENSATOR controls to RIAA. Set the MODE SELECTOR to STEREO.
2. Adjust BASS and TREBLE tone controls to 0.
3. Stand approximately 10 feet in front of and midway between the loudspeakers.

The source of sound should appear to be directly in front of you. Rotate the PHASE control from 0° to 180°. If the source of sound is not directly in front of you in 0° position reverse the leads to one loudspeaker. The PHASE control corrects phase in source material whenever necessary.

If after having made this system phase adjustment, the stereo sound seems to come from both sides of the room instead of being distributed between the loudspeakers, adjust the PHASE control to 180°. This listening effect is due to reproducing sound that is out of phase from one channel to the other. You will find some records differ from others in this respect and some tapes differ from others.

LISTENING TO A STEREO RECORD

Upon completion of the connecting and balancing instructions, the C20 is ready for use. To listen to stereo records, proceed as follows:

1. Set the MODE SELECTOR to STEREO.
2. Set the PHASE switch to 0°.

3. Set the HF CUTOFF FILTER to FLAT.
4. Set the LOUDNESS control to FLAT.
5. Rotate the INPUT SELECTOR to PHONO 1S or PHONO 2S whichever is connected to the cartridge you wish to hear.
6. Set the RECORD COMPENSATOR controls to RIAA.
7. Set the BASS and TREBLE controls to 0.
8. Place the RUMBLE FILTER pushbutton in the out position.
9. Place the TAPE COMPARE pushbutton in the out position.
10. Rotate the VOLUME (OFF-on) control to on and adjust to the desired volume.

TO ADJUST THE BALANCE CONTROL AFTER THE SYSTEM HAS BEEN BALANCED

The balance setting of some records will differ from others. If the sound is louder on the left than on the right, adjust the BALANCE control to the right to bring the sound into "left-to-right" balance. If the sound is louder on the right, adjust the BALANCE control to the left.

If after balancing your stereo system, you find that nearly all records require an adjustment of the BALANCE control, an unbalanced stereo cartridge is probably the source of this condition. This is no great disadvantage as it can be corrected by offsetting one of the power amplifier input gain settings. When switching from STEREO to REV, you will hear a change in volume as a result of this correction.

ADJUSTING FOR SPECIAL EFFECTS

HF CUTOFF FILTER. If you wish to reproduce old, badly worn records, you can minimize the surface noise by switching the HF CUTOFF FILTER to 9KC or 5KC. (See section entitled "Front Panel Facilities.")

RUMBLE FILTER. If you are using a turntable or changer which has low-frequency rumble noise, you may reduce it by pushing the RUMBLE FILTER pushbutton to the IN position. Undesirable acoustic coupling in the very low-frequency bass range may also be reduced in this manner.

BASS AND TREBLE. The tone balance which you hear when listening to an orchestra is affected by the conductor's instructions to his musicians, the acoustical environment in which you are listening, and your own subjective hearing interpretation. Even tone balance will vary within the room or hall where you listen to the music. Considering these conditions, it is easy to see why tone balance controls play a major role in correcting the following factors:

1. Each person's subjective idea of tone balance.
2. Loudspeaker frequency response characteristics.
3. Loudspeaker placement in the listening room.
4. The conductor's idea of tone balance at the time the recording was made.

5. The microphone frequency response characteristics.
6. The recording process influences.

These factors can be considered as environmental influences. The BASS and TREBLE controls are designed to provide a degree of compensation for the effects of environment. Listen to your system with each control set at zero. If you wish to reduce treble in relation to bass, rotate the TREBLE control counterclockwise until the tone balance sounds correct to you. Do not be surprised if you find your preference in tone changing from time to time. These controls will modify tone balance without introducing any undesirable effects.

Tone balance may be accented in the treble range by rotating the TREBLE control clockwise. Similarly tone balance in the bass range may be modified up or down by use of the BASS control.

RECORD COMPENSATOR. The RECORD COMPENSATOR controls are used to correct for the necessary program equalization which the recording process introduces. Recording requires a change in the distribution of intensity with frequency. Without compensation a magnetic cartridge would sound deficient in the bass range and overly bright or shrill in the treble range. Recommended settings of the RECORD COMPENSATOR controls of the C20 for monophonic records are given in Table 3, page 12.

LOUDNESS CONTROL. Due to a selective shift in sensitivity of the human hearing, music reproduced at very low volume loses its bass and treble. The family of curves showing this effect are known as Fletcher-Munson curves. (See Figure 13.) The LOUDNESS control on the C20 corrects for this effect. When you wish to listen to music at a greatly reduced loudness level and yet hear base and treble, turn the LOUDNESS control to reduce intensity. Some users of the C20 leave the LOUDNESS control at positions 1 or 2 to correct for environmental conditions such as loudspeaker characteristics, room placement, etc.

USING THE C20 WITH A STEREO TUNER

A stereo tuner may be used with the C20 by plugging the left and right channels into TUNER INPUT 1 or 2. When the INPUT SELECTOR switch is turned to the TUNER positions, the record compensator pre-amplifier is disconnected and the RECORD COMPENSATOR controls will not require adjustment. The MODE SELECTOR switch, BALANCE control, PHASE switch, LOUDNESS control, BASS and TREBLE controls, the RUMBLE FILTER, TAPE JACK switch, and VOLUME (OFF-on) control all operate under this condition and should be used in the same way as with any other program.

USING THE C20 WITH A STEREO TAPE MACHINE

A stereo tape machine with its own playback pre-amplifiers should be plugged into the TAPE INPUTS—not the TAPE HEAD inputs. The information on adjusting the C20 for listening to a stereo tuner will also apply when listening to a tape machine.

USING THE C20 FRONT PANEL TAPE INPUT JACKS

Two tape machines can be used with the C20 Stereophonic Preamplifier. After you have connected your tape machine to the rear panel of the preamplifier you may have someone bring in a portable machine to make a copy of one of your tapes or to listen to one of his tapes on your system. With the C20 you no longer have to unplug your permanent machine. The C20 is supplied with two cables. The cables have phone plugs on one end to plug into the front panel of the C20 and pin jacks on the other end to plug into any tape machine. (Adapters are available at any Hi-Fi retailer to permit pin plugs to connect with phone jacks.)

To listen to the portable or second tape machine plug the pin jack end of the two C20 cables, mentioned above, into the tape machine output. Connect the telephone plugs into the telephone jacks on the C20 front panel. The left jack supplies the left channel. The right jack supplies the right channel. Rotate the INPUT SELECTOR switch to TAPE. When the tape jack switch is depressed to the IN-PLAYBACK position, the permanent tape machine output is disconnected from the rear panel. The portable tape machine is now connected and any program originating in this machine will be heard through the C20, and will also be available from the C20-TAPE OUTPUT to drive the permanent tape machine input. This feature allows you to copy a tape from the portable machine into your permanent machine, provided your permanent machine has its own recording pre-amplifier.

To record on the portable machine plug the two phono pin plugs of the two C20 cables into the input of the portable machine. Leave the telephone plugs connected to the C20 telephone jacks on the front panel. Operate the tape jack switch to the OUT position. The permanent tape machine will be reconnected. Now any program picked up by the INPUT SELECTOR switch will be available to drive the portable machine. You can now make a copy on the portable machine of any tape played on the permanent machine. You can copy any other program source onto both tape machines at the same time.

When recording from one tape machine to the other the only controls that are effective are the HF CUTOFF FILTER and the TAPE JACK switch. (Note: Some portable tape machines will drive the C20 even though the TAPE JACK switch is in the OUT position. This is not a normal circuit use and a distorted signal usually results. For low-distortion operation follow the recommended procedure.

USING THE C20 WITH TAPE DECKS

The C20 Stereo Preamplifier may be used with tape decks which do not have playback preamplifiers. Tape heads require a form of playback compensation. Setting the RECORD COMPENSATOR controls to the TAPE positions provides correct playback for tape heads and eliminates the need for using playback preamplifiers with tape decks. (Note, however, that the C20 cannot conveniently be used to record on tape. If you need recording facilities in a tape machine, a recording preamplifier will be required. In many tape machines this preamplifier serves both playback and record functions.)

USING THE C20 WITH MICROPHONES FOR STEREO

Microphones in stereo may be used with the C20. If the microphones are low level (low output — 2 to 10MV) then they may be plugged into either an unused pair of low level PHONO 2-10MV jacks or an unused pair of low level TAPE HEAD 2-10MV jacks.

If the microphones are medium-level (10 to 70 MV), then they may be plugged into either an unused pair of high-level PHONO 10-70 MV jacks or an unused pair of high-level TAPE HEAD 10-70 MV jacks.

When reproducing from microphones in phono or tape head channels set the BASS RECORD COMPENSATOR control to 0 and the TREBLE RECORD COMPENSATOR control to TAPE. This adjustment gives a flat response for the microphones.

If high-output microphones (100 MV and up) are used, plug them into the auxiliary channel. In this channel the RECORD COMPENSATOR controls do not operate and it will be necessary to adjust the microphones. All previous information given on microphones applies.

MONOPHONIC RECORD SETTINGS

For several years record companies used many different recording methods in an effort to give maximum entertainment value when listening to their records.

If you wish to listen to monophonic records, switch the INPUT SELECTOR to PHONO 1 M or PHONO 2 M. Vertical output from the stereo cartridges is cancelled by operating the INPUT SELECTOR to the M (monophonic) positions. When listening to monophonic records vertical output consists only of undesirable sounds such as record scratch. The recommended settings are as follows:

Table 3. Recommended Settings of the RECORD COMPENSATOR Controls of the C20 for Monophonic Records

Manufacturer	Speed	RECORD COMPENSATOR		Manufacturer	Speed	RECORD COMPENSATOR	
		BASS (Turnover)	TREBLE (Roll-Off)			BASS (Turnover)	TREBLE (Roll-Off)
Allegro	33	LP	LP	Atlantic	33	RIAA	LP
American Recording Society	33	RIAA	-12	Audiophile	78	300	-10
Angel	33	RIAA	-12	Bach Guild Banner	33	LP	LP

Table 3. Recommended Settings of the RECORD COMPENSATOR Controls of the C20 for Monophonic Records (Cont)

Manufacturer	Speed	RECORD COMPENSATOR		Manufacturer	Speed	RECORD COMPENSATOR	
		BASS (Turnover)	TREBLE (Roll-Off)			BASS (Turnover)	TREBLE (Roll-Off)
Bartok Boston	33	LP	LP	London	78	300	-5
Blue Note	33	400	-12	Lyricord	33	LP	LP
Caedmon	33	LP	-12	Mercury	33	400	-12
Capital	45	RIAA	-12		45		
Capital	33	400	-12		78		
Canyon	33	400	-12	MGM	33	RIAA	-12
Capital-Cetra Colosseum					45		
Cetra-Soria Columbia	33	LP	LP		78		
Columbia	45	RIAA	LP	Montilla	33	RIAA	-12
Columbia	78	300	LP	New Records Oceanic Oxford	33	LP	LP
Contemporary Concert Hall Coral	33	400	-12	Period	33	RIAA	LP
Cook	33	RIAA	-12	Philharmonia	33	400	-12
Decca	33	LP	LP	Rachmaninoff Society	33	LP	LP
Dial	45			RCA Victor (Old)	33	RIAA	-10
	78				45		
	33				78		
Electra	33	LP	LP	RCA Victor (H.M.V.) (New RIAA Curve)	33	RIAA	-12
Ems	33	400	-12		45		
Epic	33	LP	LP		78		
Esoteric	33	RIAA	-12	Remington	33	RIAA	LP
European	78	300	-5	Renaissance	33	LP	-12
Festival	33	LP	LP	Stradivari	33	LP	LP
Folkways	33	LP	LP	Technicord	78	RIAA	-12
Good	33	400	-12	Telefunken	78	400	-5
Time Jazz				Urania (Old)	33	LP	LP
Handel Soc. Haydn Soc.	33	LP	LP	Urania (New)	33	400	-12
London	33	LP	-10	Vanguard	33	LP	LP
				Vox Westminster			
				RIAA, ORTHO, New NARTB, New AES used on recordings made since 1955		RIAA	RIAA

OPERATING CURVES

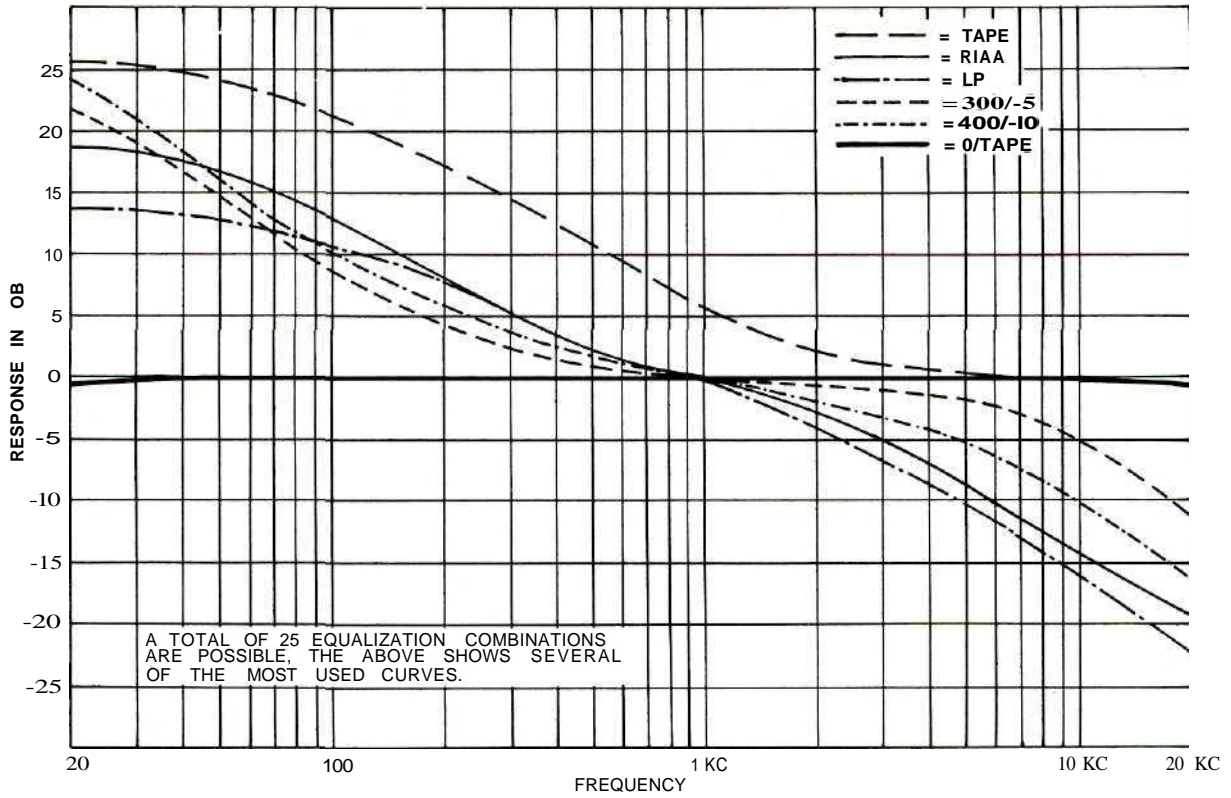

Figure 10. RECORD COMPENSATOR Controls

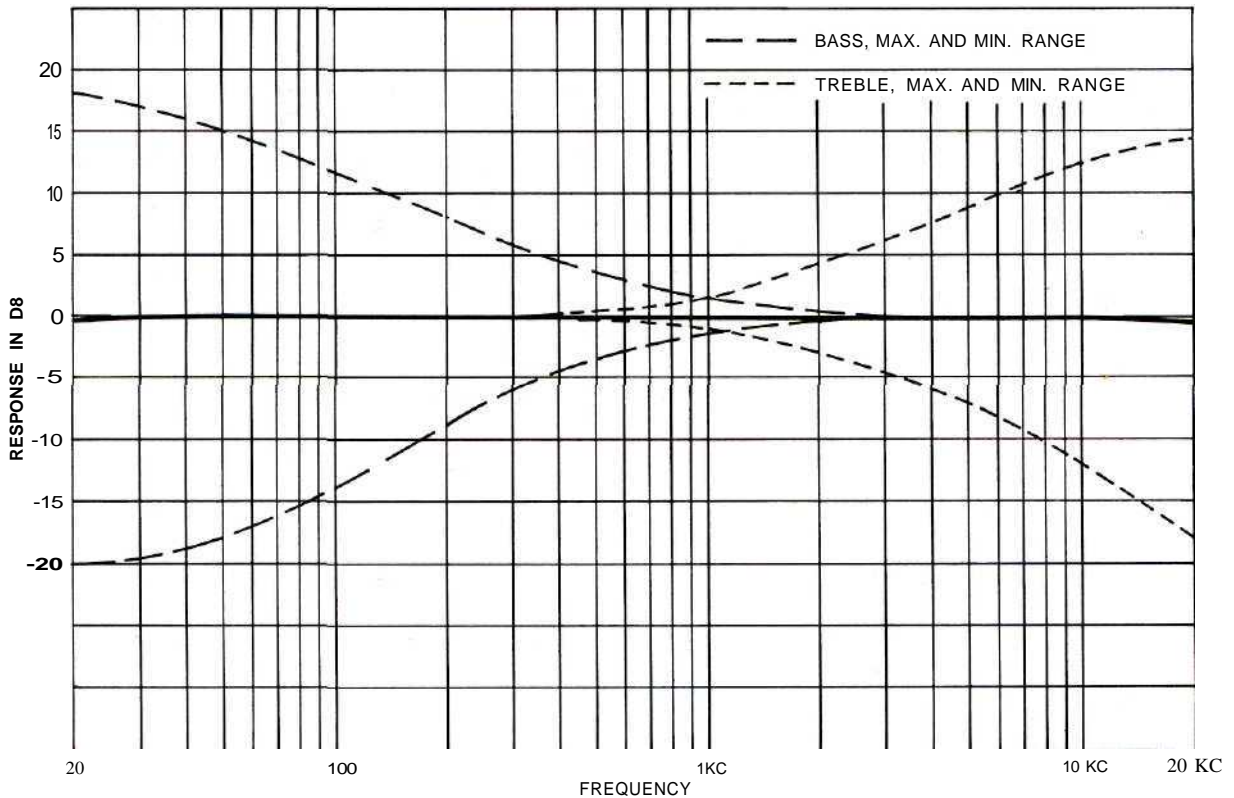

Figure 11. BASS and TREBLE Controls

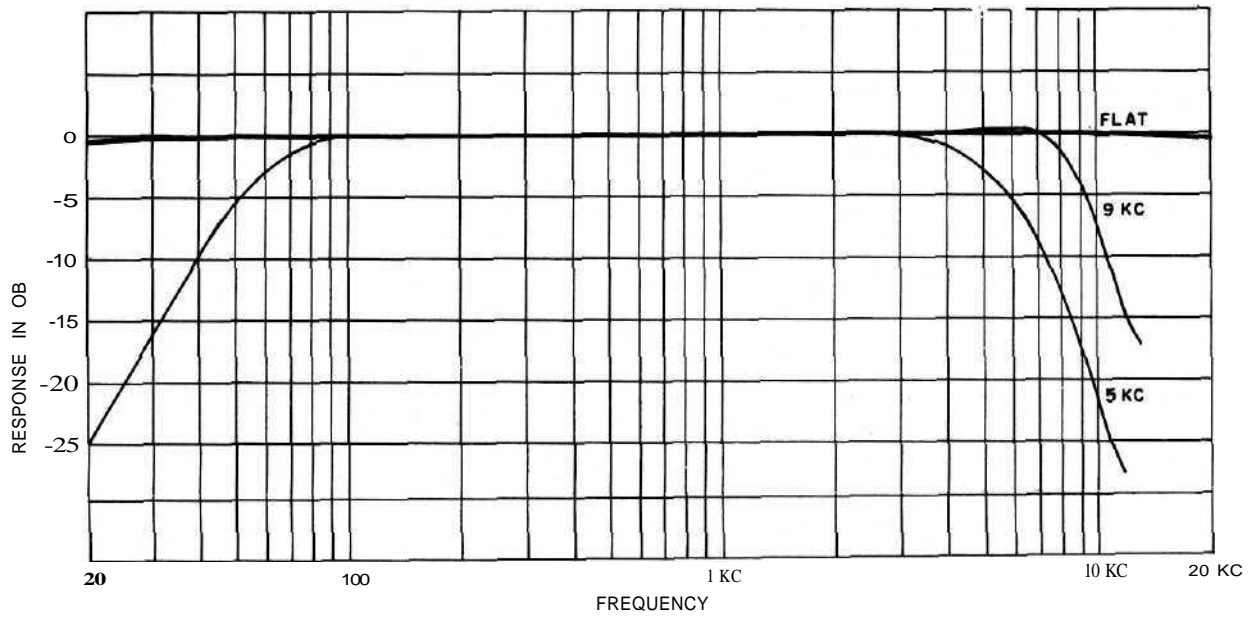

Figure 12. RUMBLE FILTER and HF CUTOFF FILTER

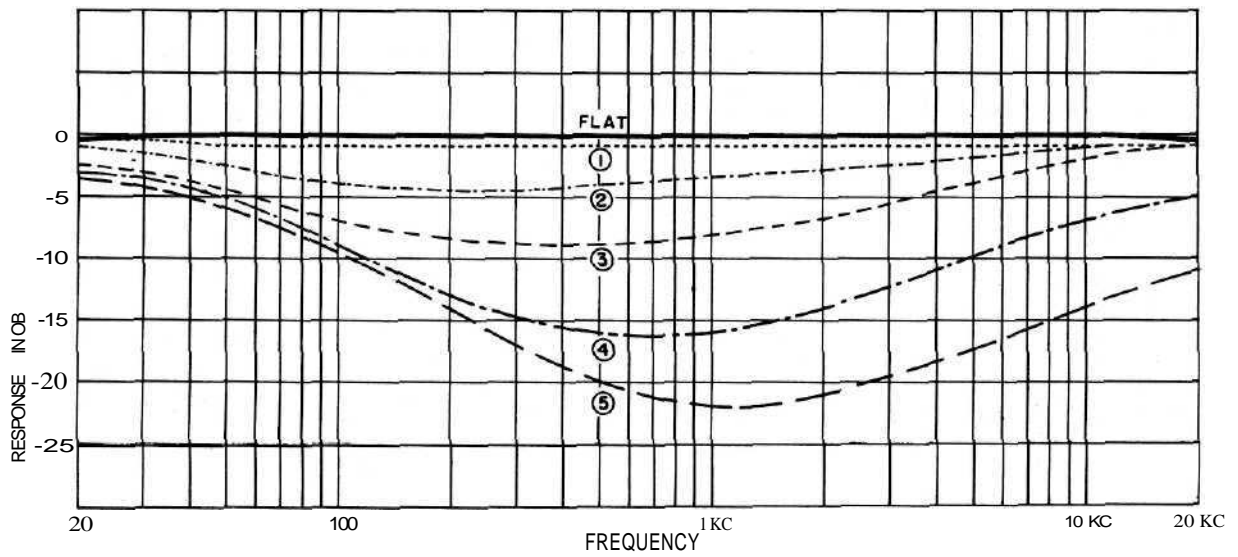

Figure 13. LOUDNESS Control

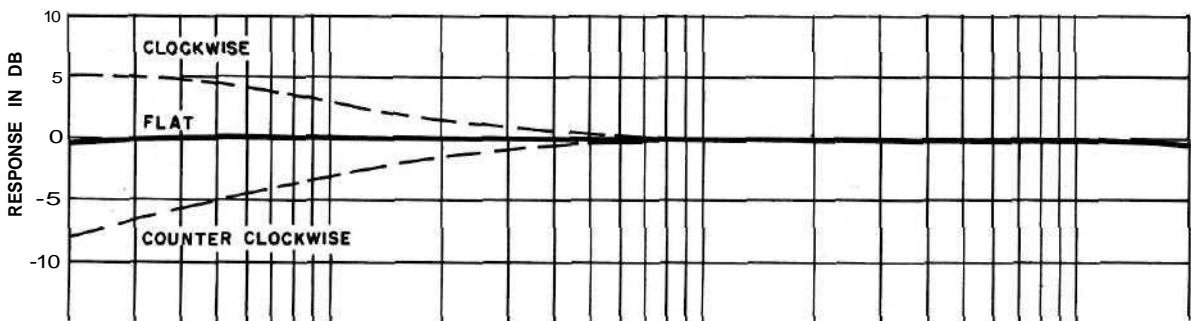

Figure 14. BASE TRIM Controls—separate controls are provided for R and L outputs.

Your C20 will give you many years of pleasant and satisfactory performance. If you have any questions concerning the operation or maintenance of this pre-amplifier please contact:

Customer Service

McIntosh Laboratory Inc.

2 Chambers Street

Binghamton, New York

Our telephone number is 723-5491.

The direct dial area code is 607.

GUARANTEE

McIntosh Laboratory Incorporated guarantees this equipment to perform as advertised. We also guarantee the mechanical and electrical workmanship and components of this equipment to be free of defects for a

period of 90 days from date of purchase. This guarantee does not extend to components damaged by improper use nor does it extend to transportation to and from the factory.

3-YEAR FACTORY SERVICE CONTRACT

An application for a FREE 3-YEAR FACTORY SERVICE CONTRACT is included in the pocket in the back cover of this manual. The FREE 3-YEAR FACTORY SERVICE CONTRACT will be issued by McIntosh Laboratory upon receipt of the completely filled out application form. The term of this contract is defined in the

3-year factory service contract. If the application is not mailed to McIntosh Laboratory, only the services offered under the standard 90-day guarantee will apply on this equipment. TAKE ADVANTAGE OF 3 YEARS OF FREE FACTORY SERVICE BY FILLING IN THE APPLICATION NOW.

In Canada: manufactured under license by:

McCurdy Radio Industries, Ltd.

22 Front Street West

Toronto, Canada

McIntosh **LABORATORY INC.**

2 CHAMBERS STREET, BINGHAMTON, N. Y.

Made in U.S.A.

Phone —Area Code 607-723-5491